



PORTE DES ENFERS

© MOUSTAGUA



PORTE DES ENFERS

© MOUSTAGUA

Matériel nécessaire :

- Papier bristol 160 g/m² minimum
- Ciseaux
- Cutter
- Colle liquide en tube
- Beaucoup de patience...

Notice d'assemblage :

	----- Plis montagne (pointillets) ● faire un pli en montagne.	<p>Les points de colle (points colorés) montrent où appliquer la colle.</p> <ul style="list-style-type: none">● Point de colle (point rouge) Coller les parties avec le même numéro ensemble.● Point de colle (point vert) Coller dans la même partie.● Point de colle (point bleu) Coller à l'arrière de l'autre partie.
	- - - - - Plis vallée (tirets points tirets) ● faire un pli en vallée.	
	———— Ligne de découpe (ligne pleine) ● Couper le long de la ligne.	
	———— Ligne d'entaille (ligne pleine) ● Couper le long de la ligne.	

IMPORTANT : Lors de l'impression de ce PDF, vérifier que l'option « mise à l'échelle » est bien réglée sur « aucune » dans la page d'impression du document.

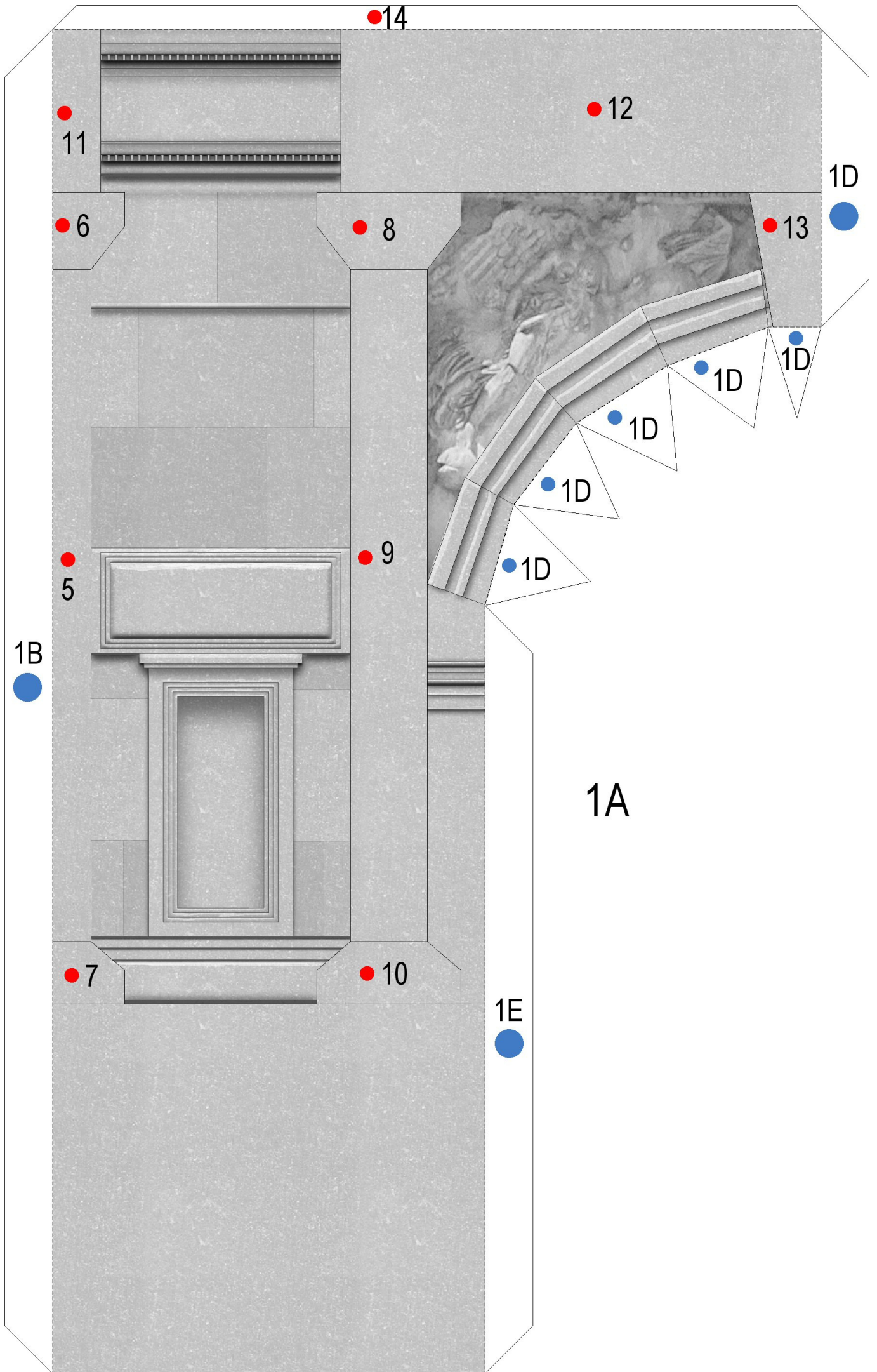

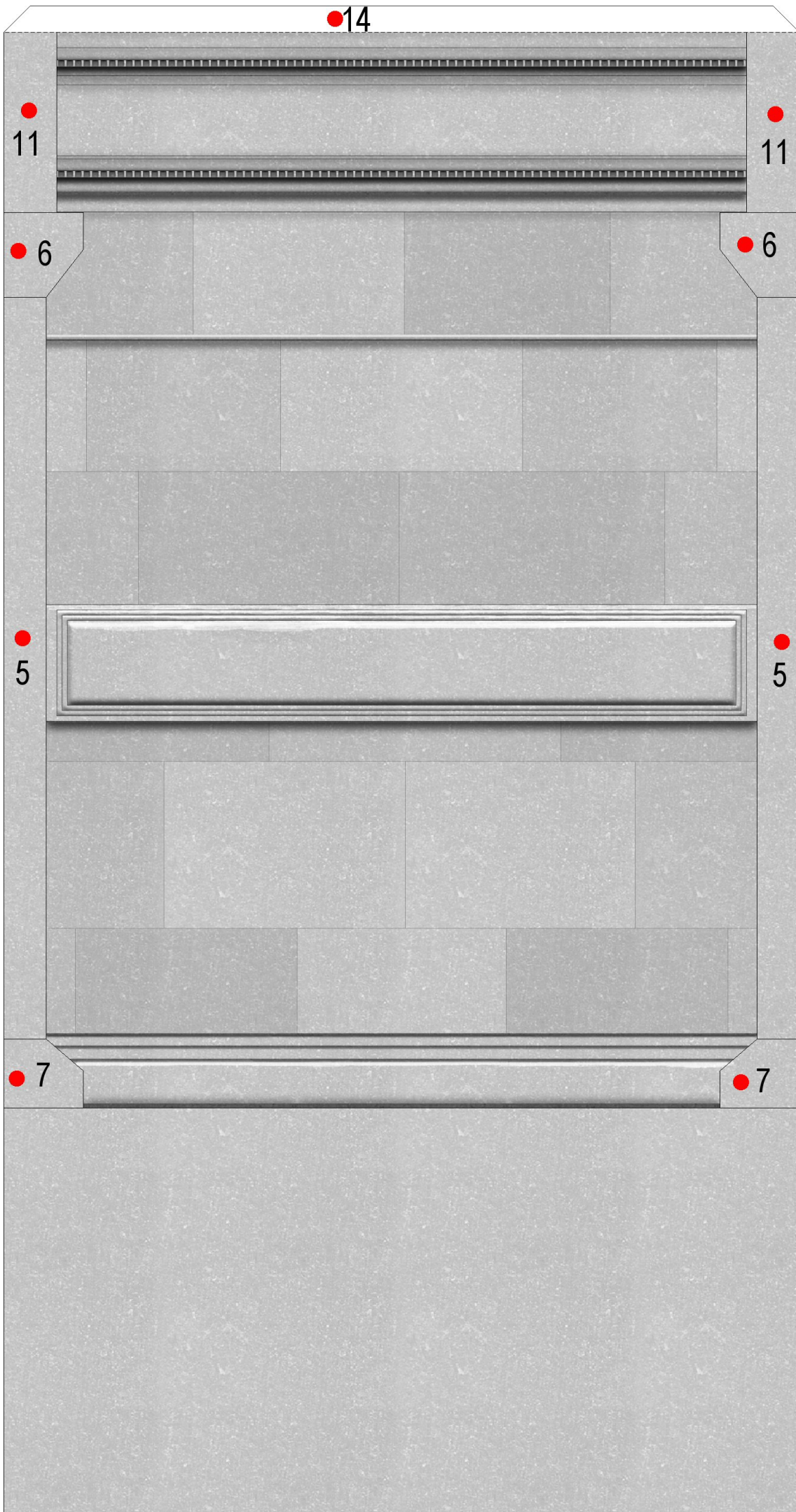

1B

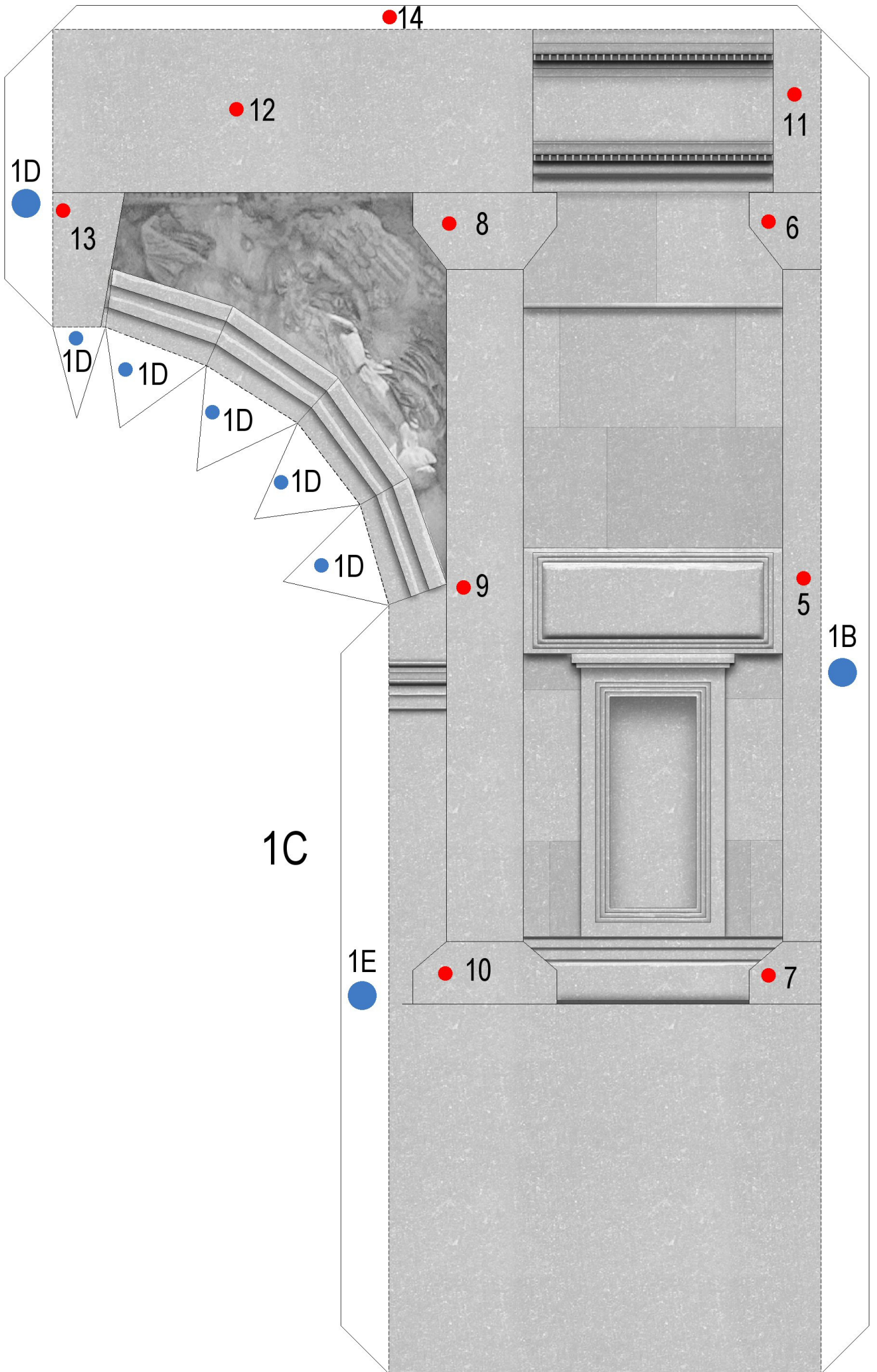

1D

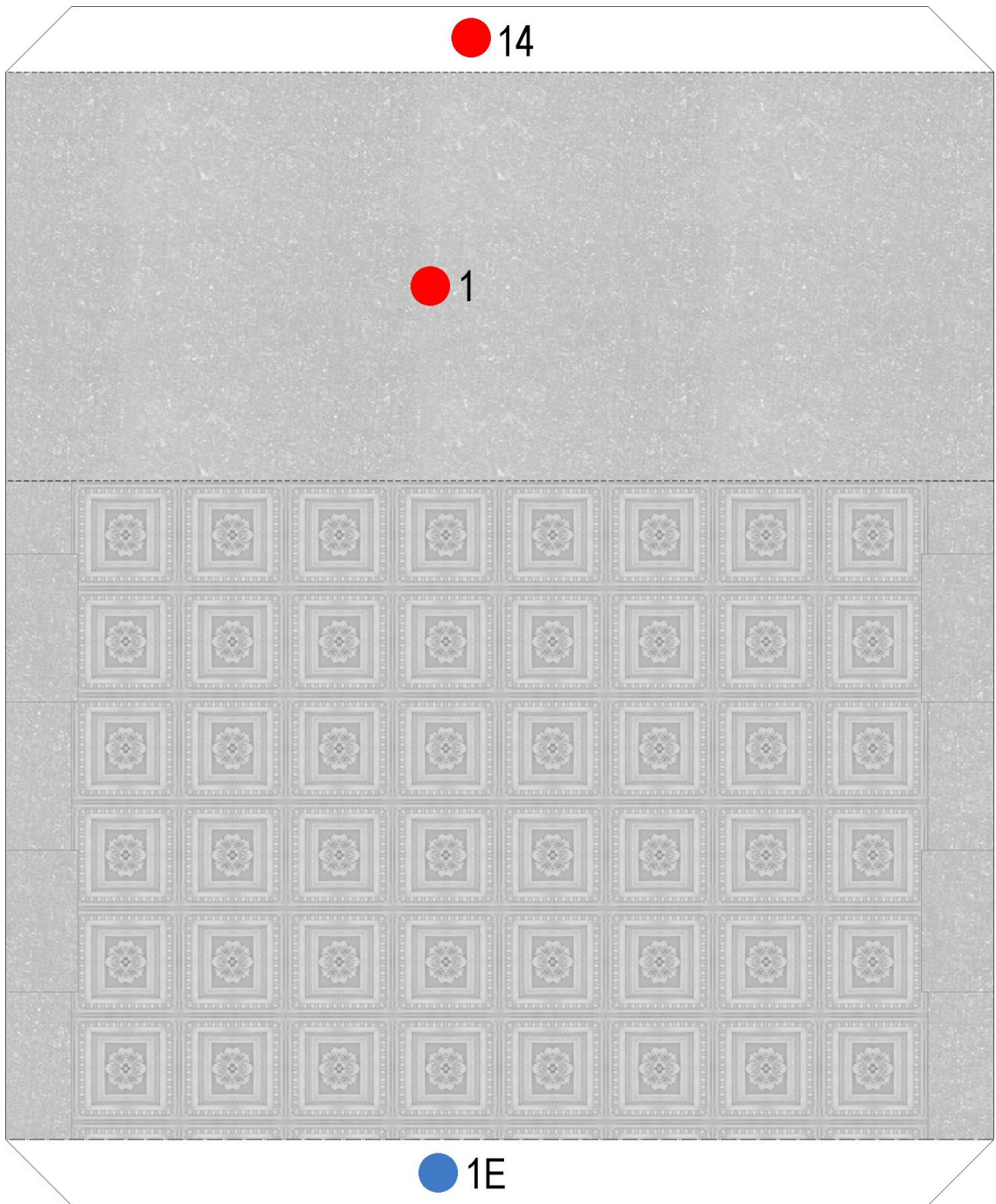

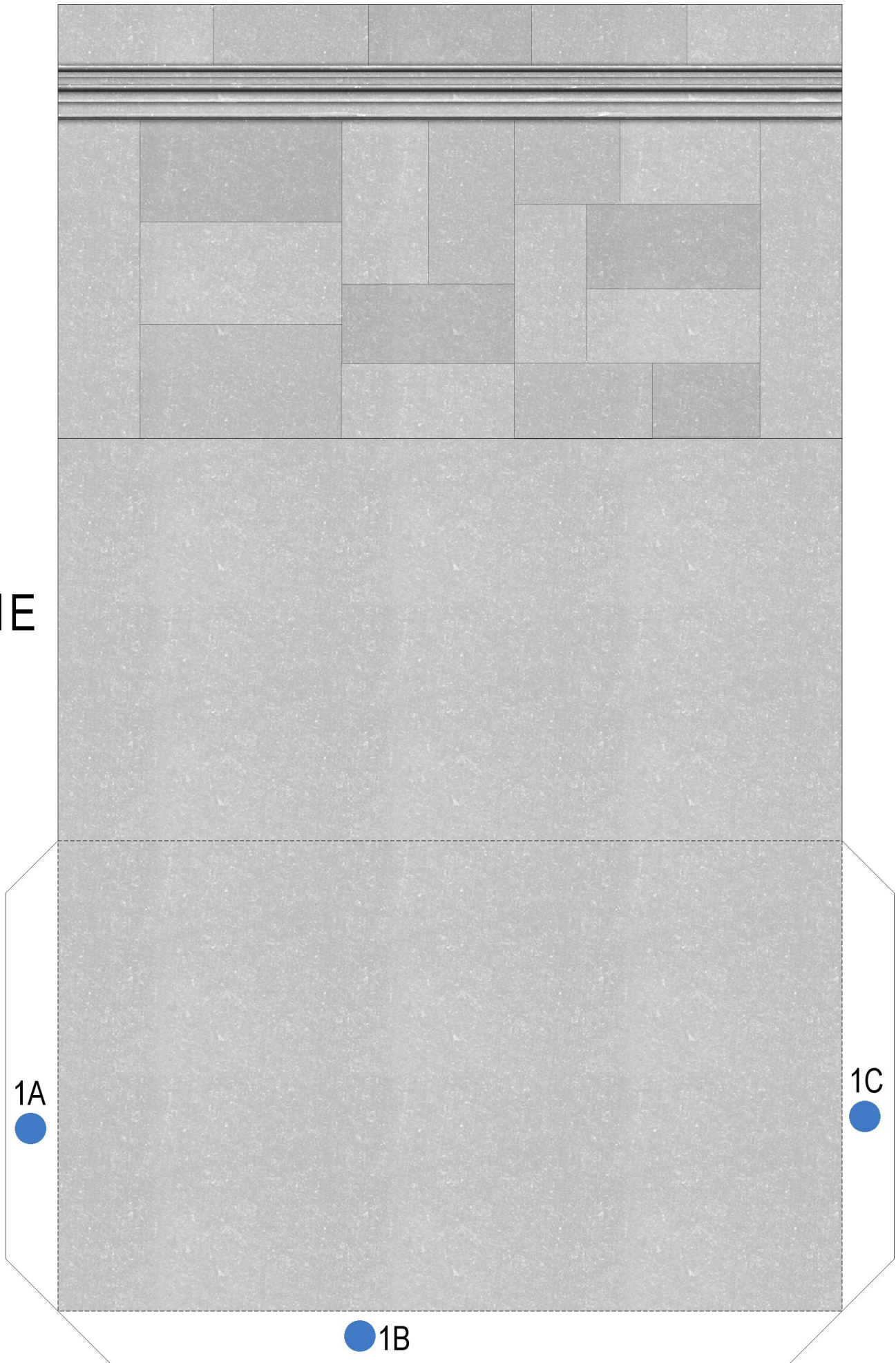

1E

1A



1B

1C



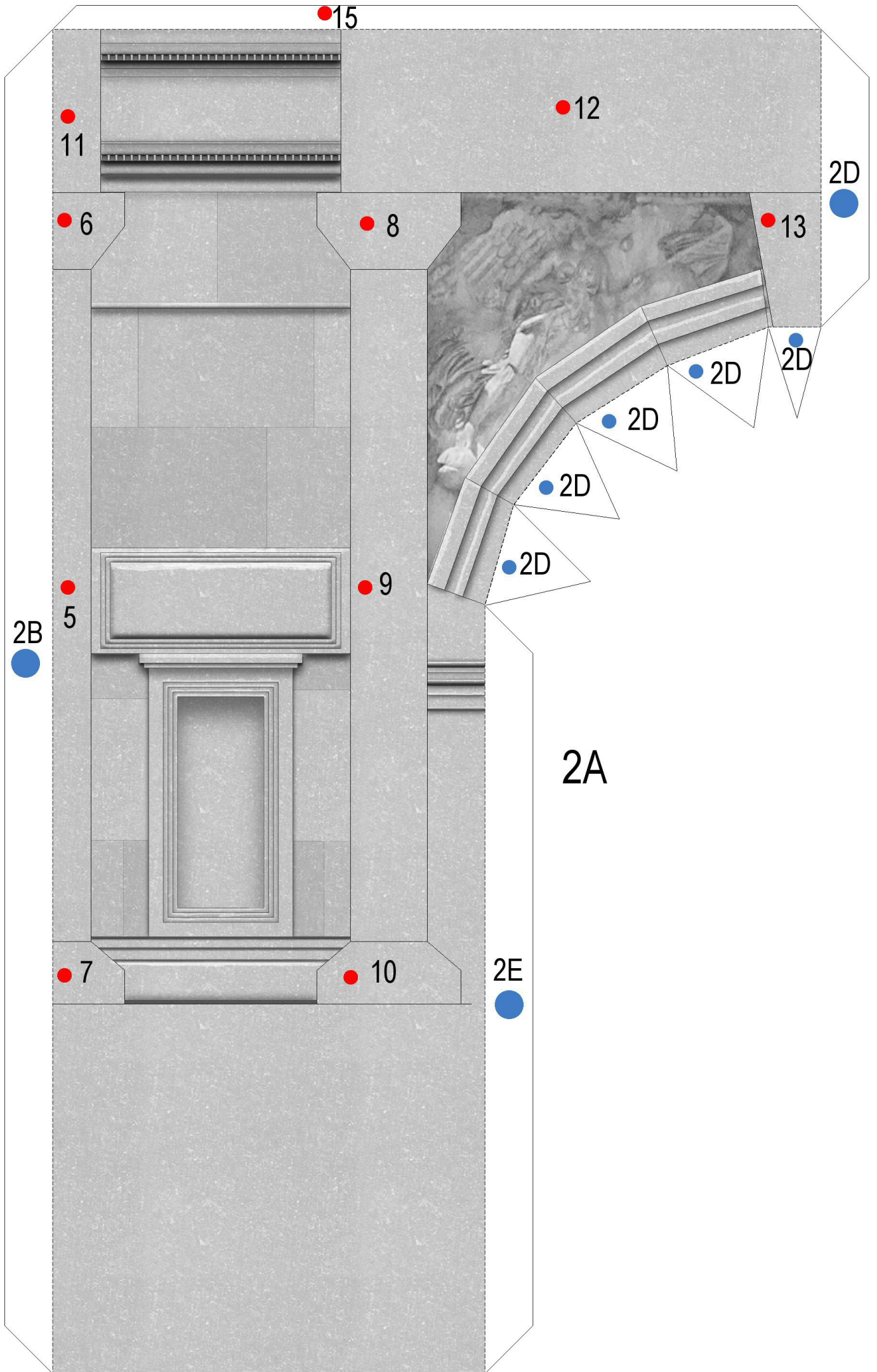

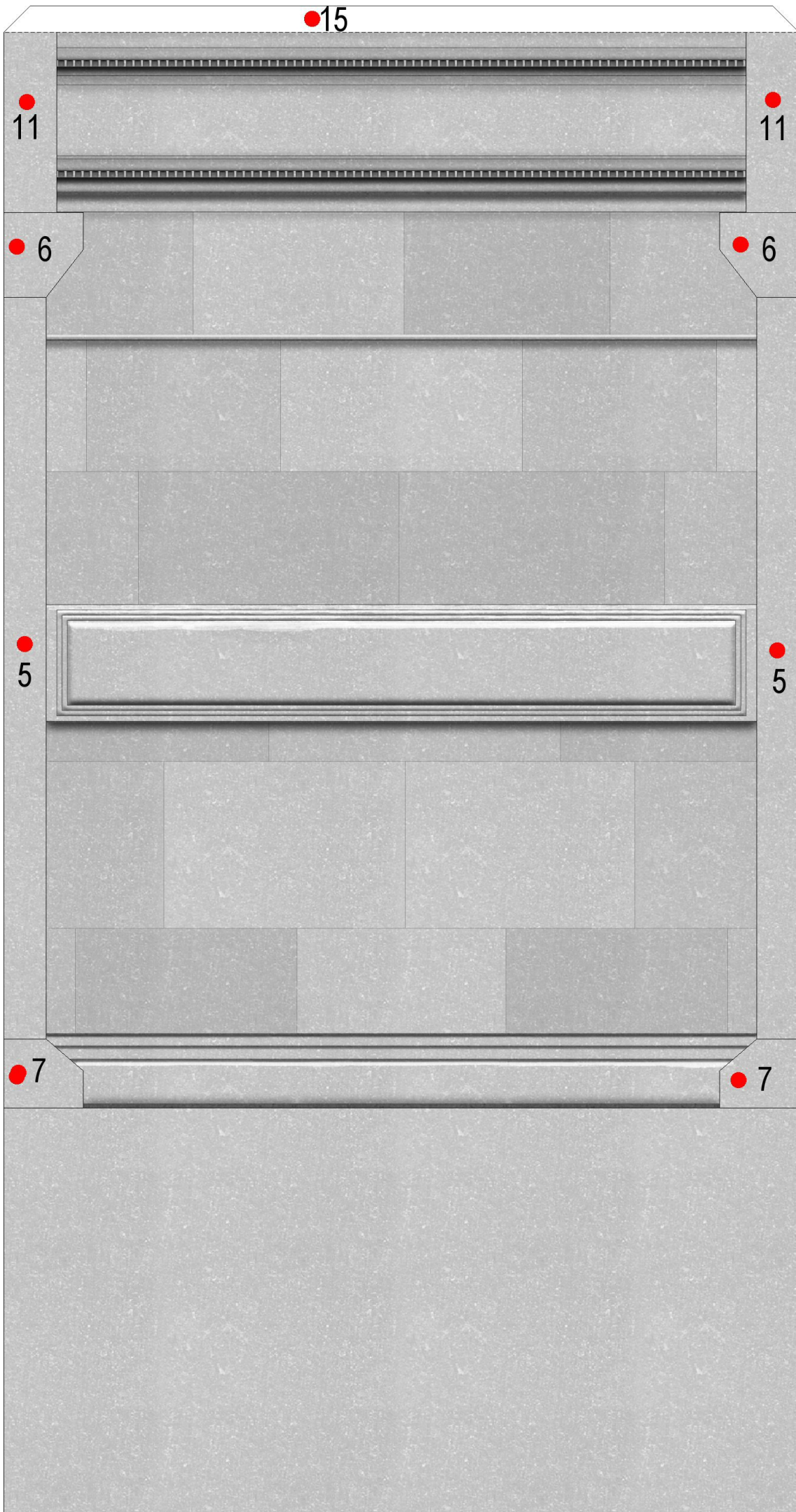

2B

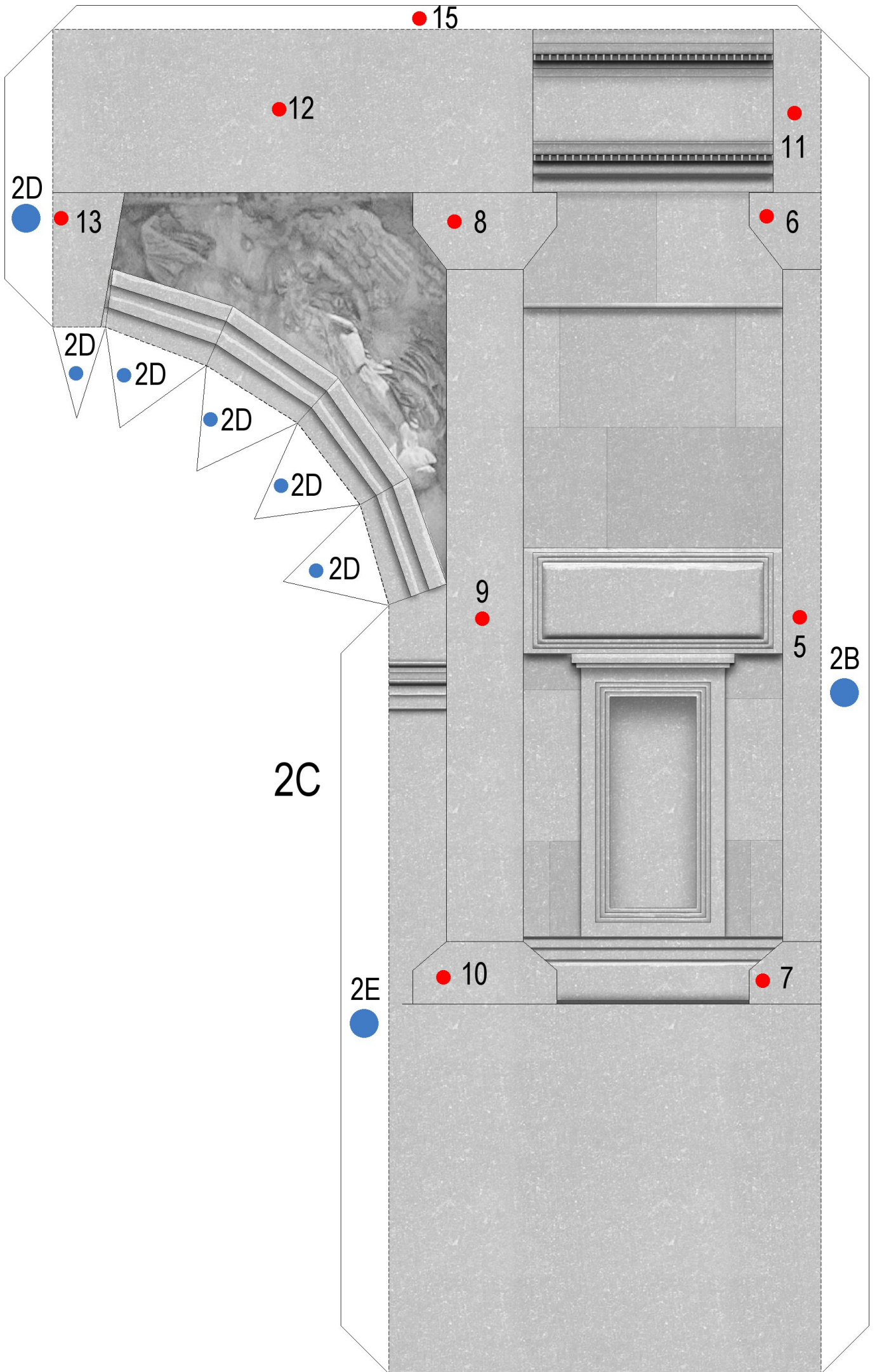

15

12

11

2D

13

8

6

2D

2D

2D

2D

2D

9

5

2B

2C

2E

10

7

2D

● 15

● 1

● 2E

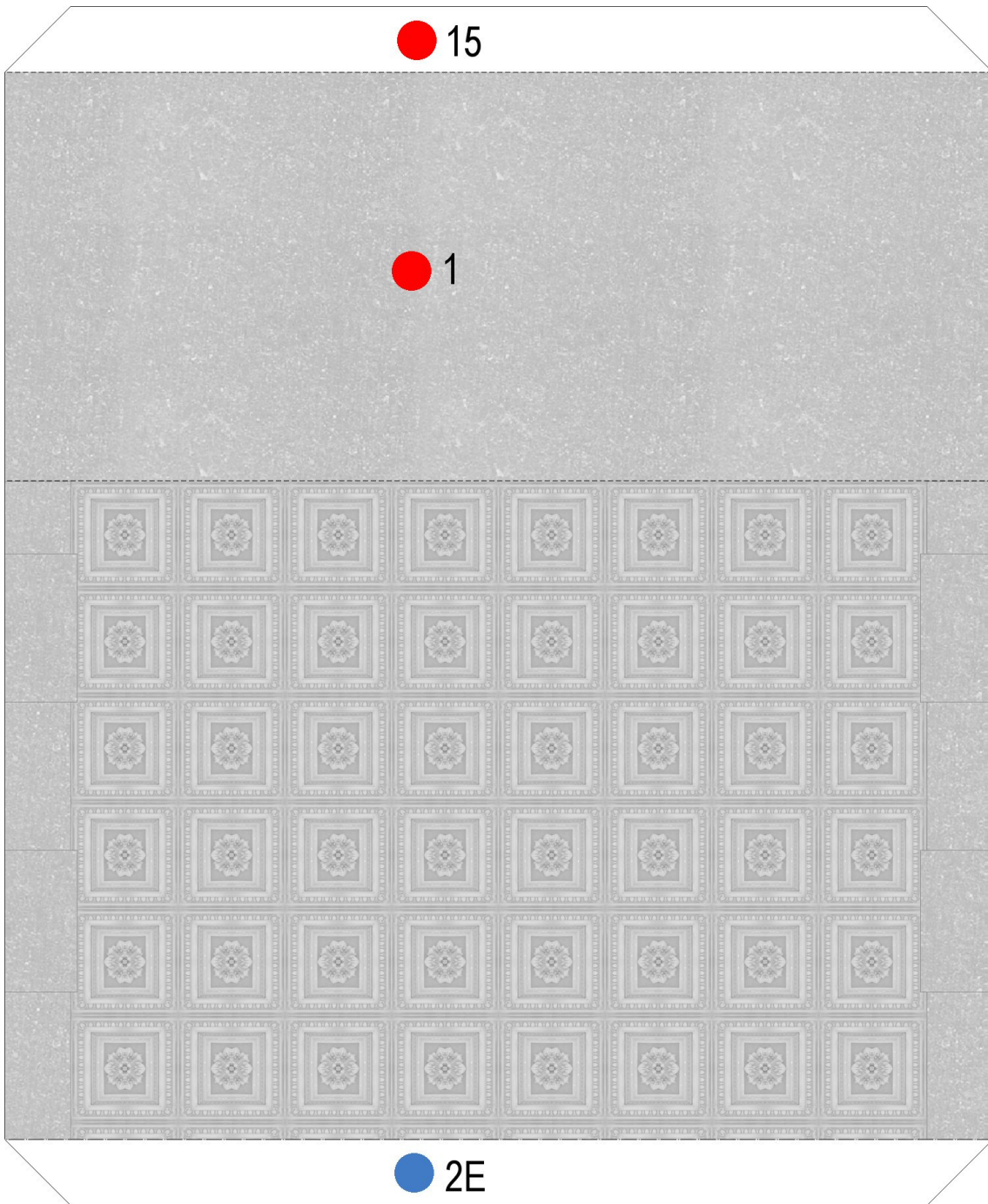



2E

2A ●

2C ●

● 2B

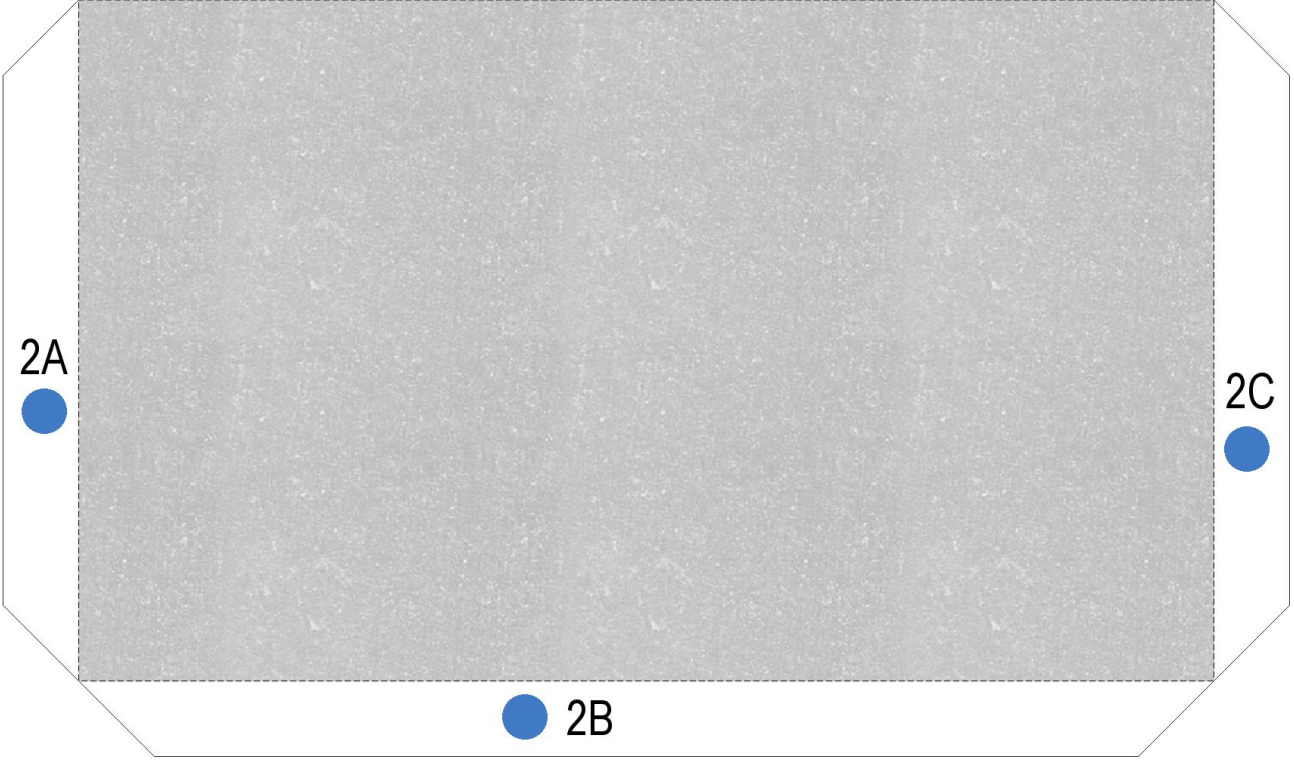

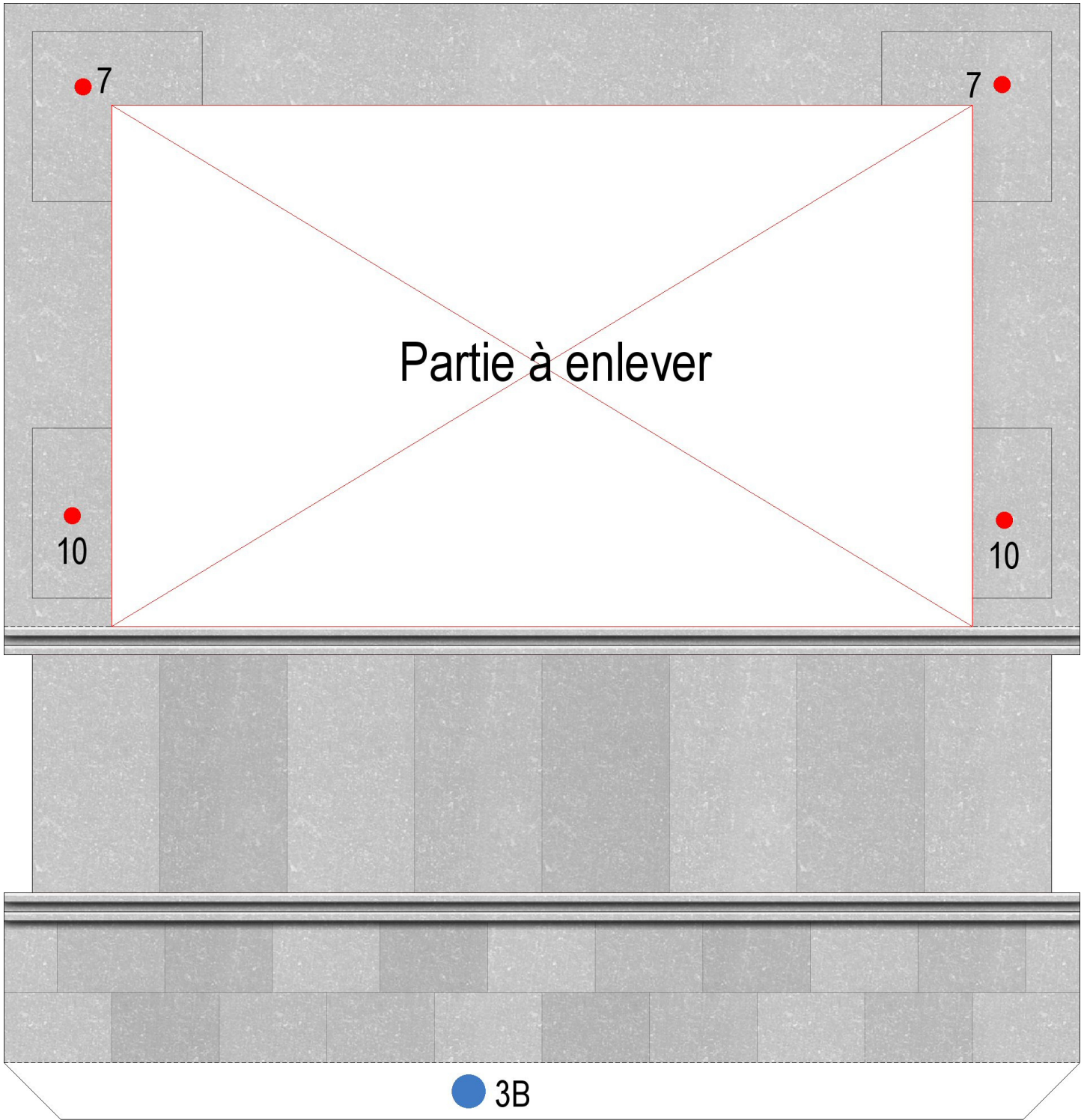

● 3B

3A

● 3A

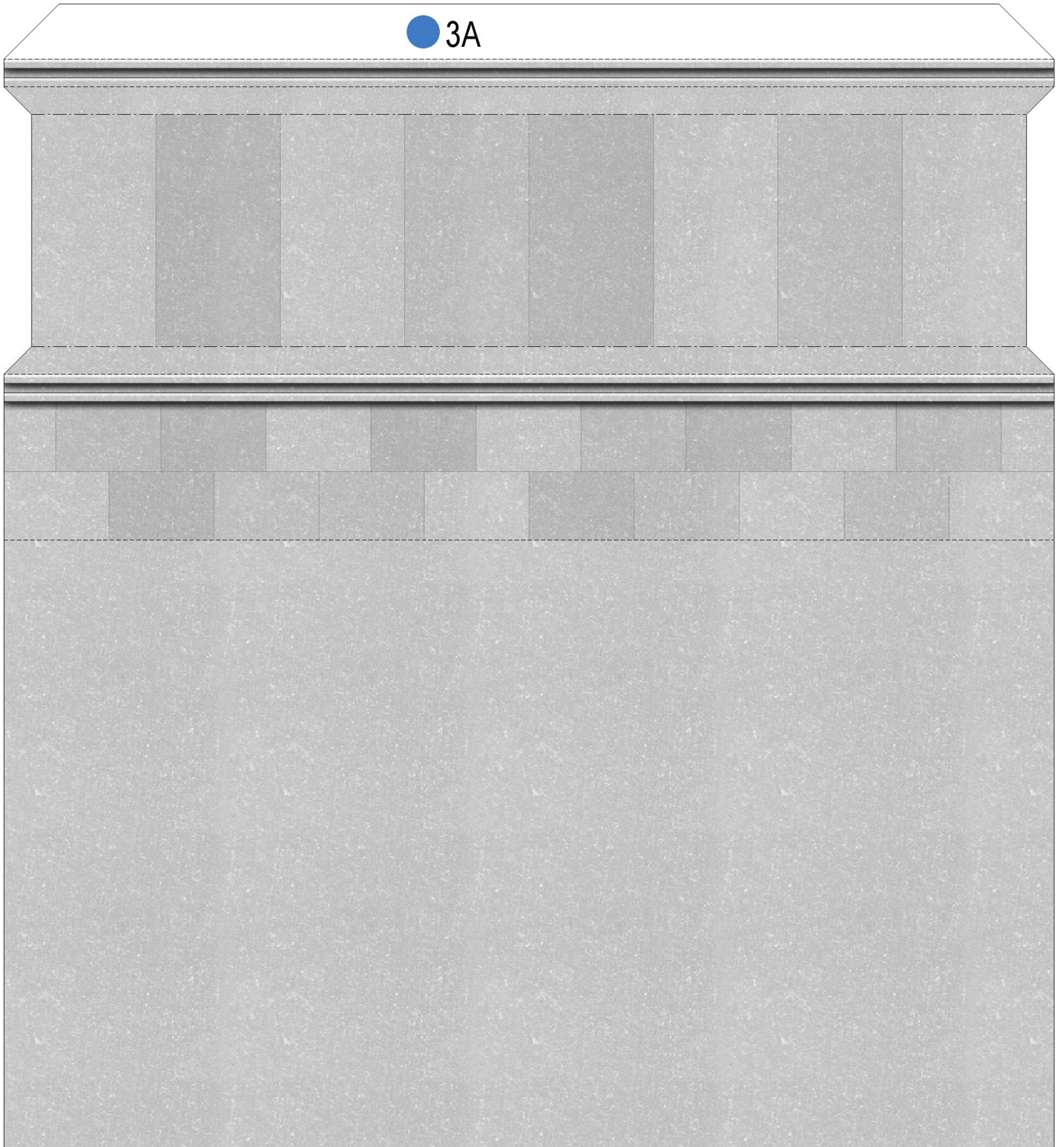

3B

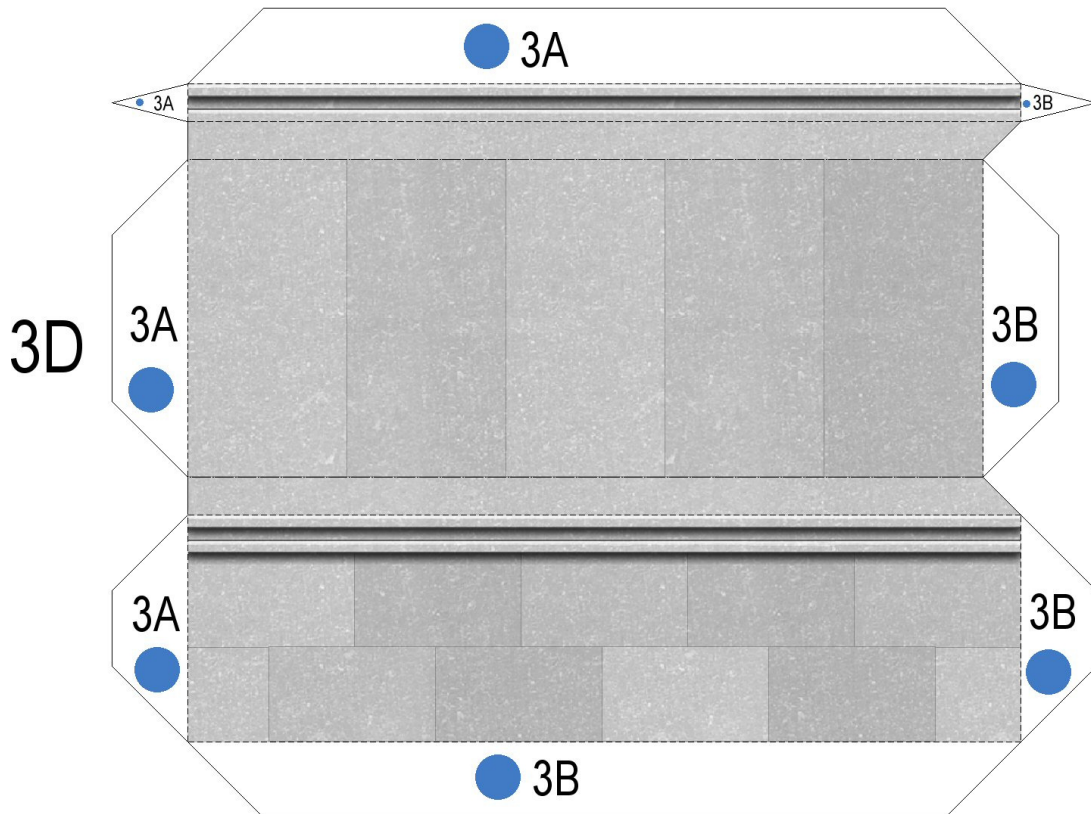
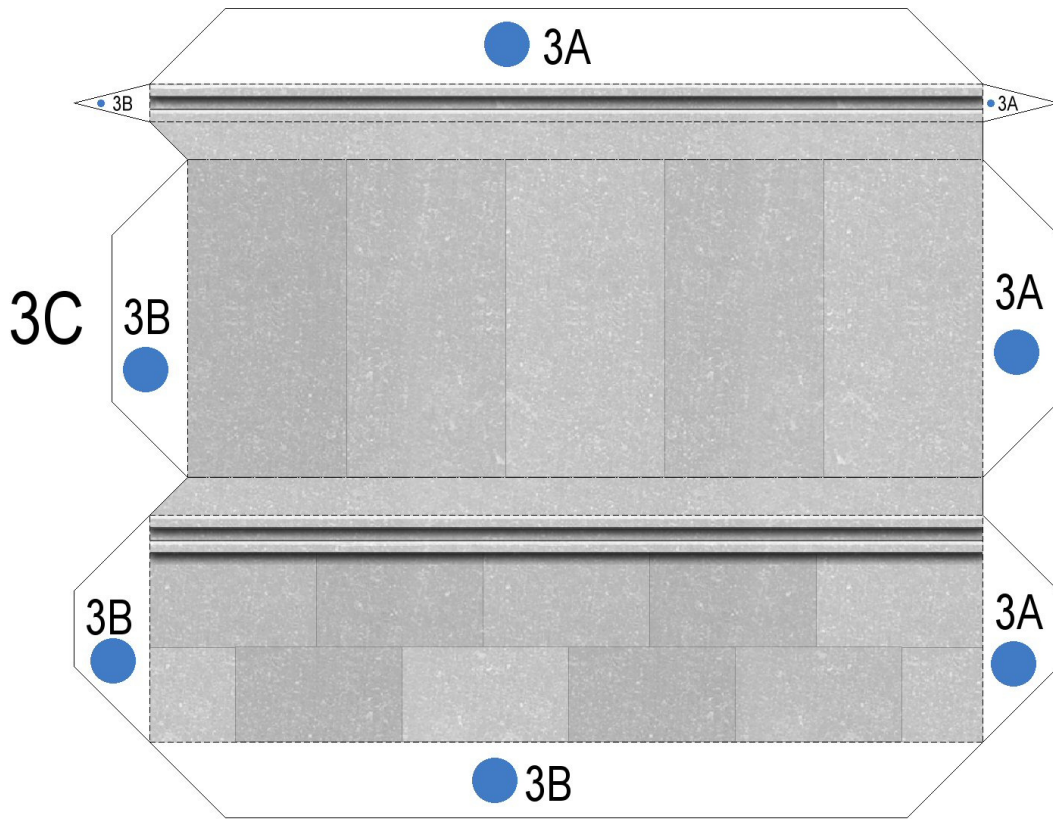

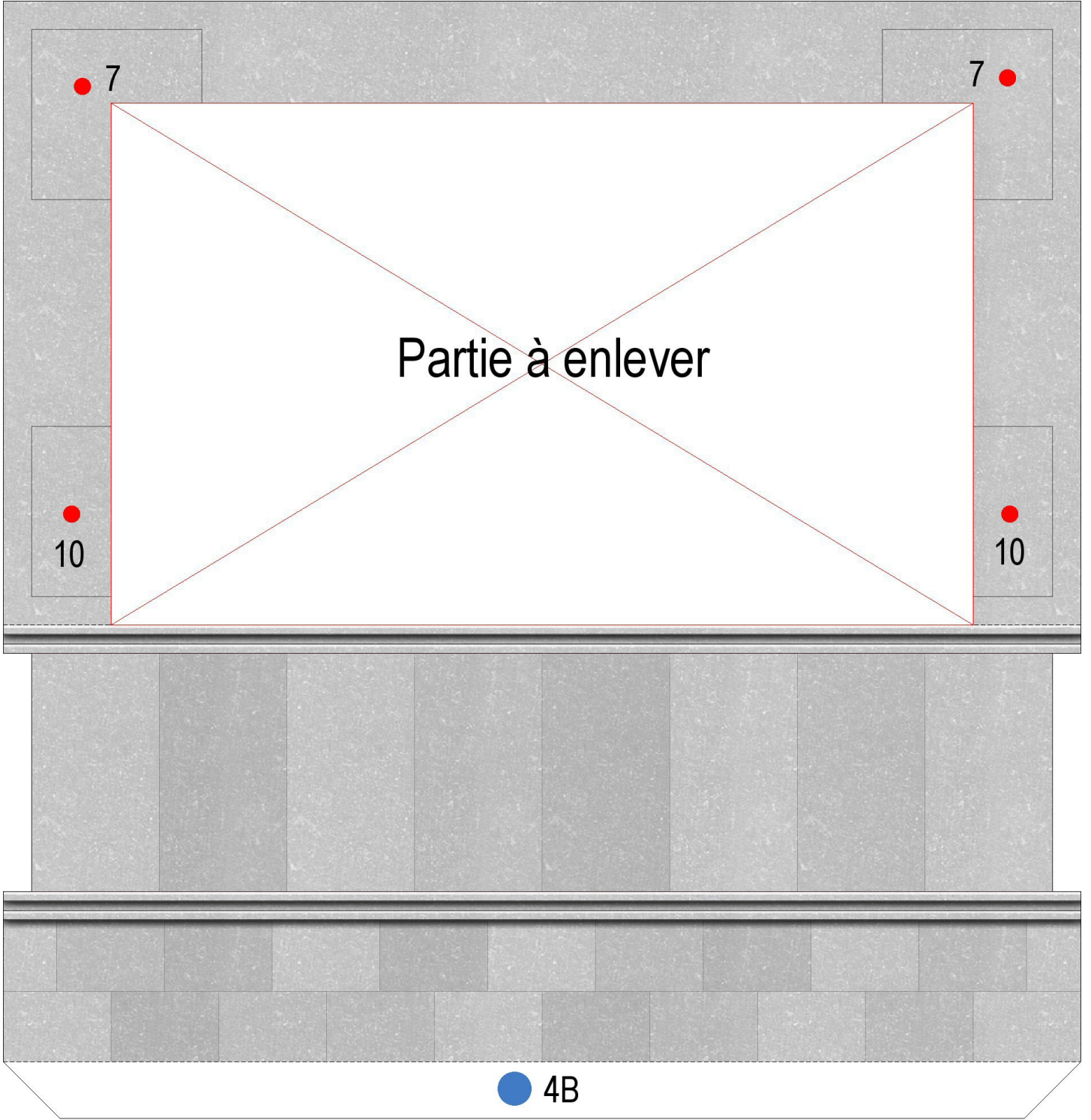

4A

4B

● 4A

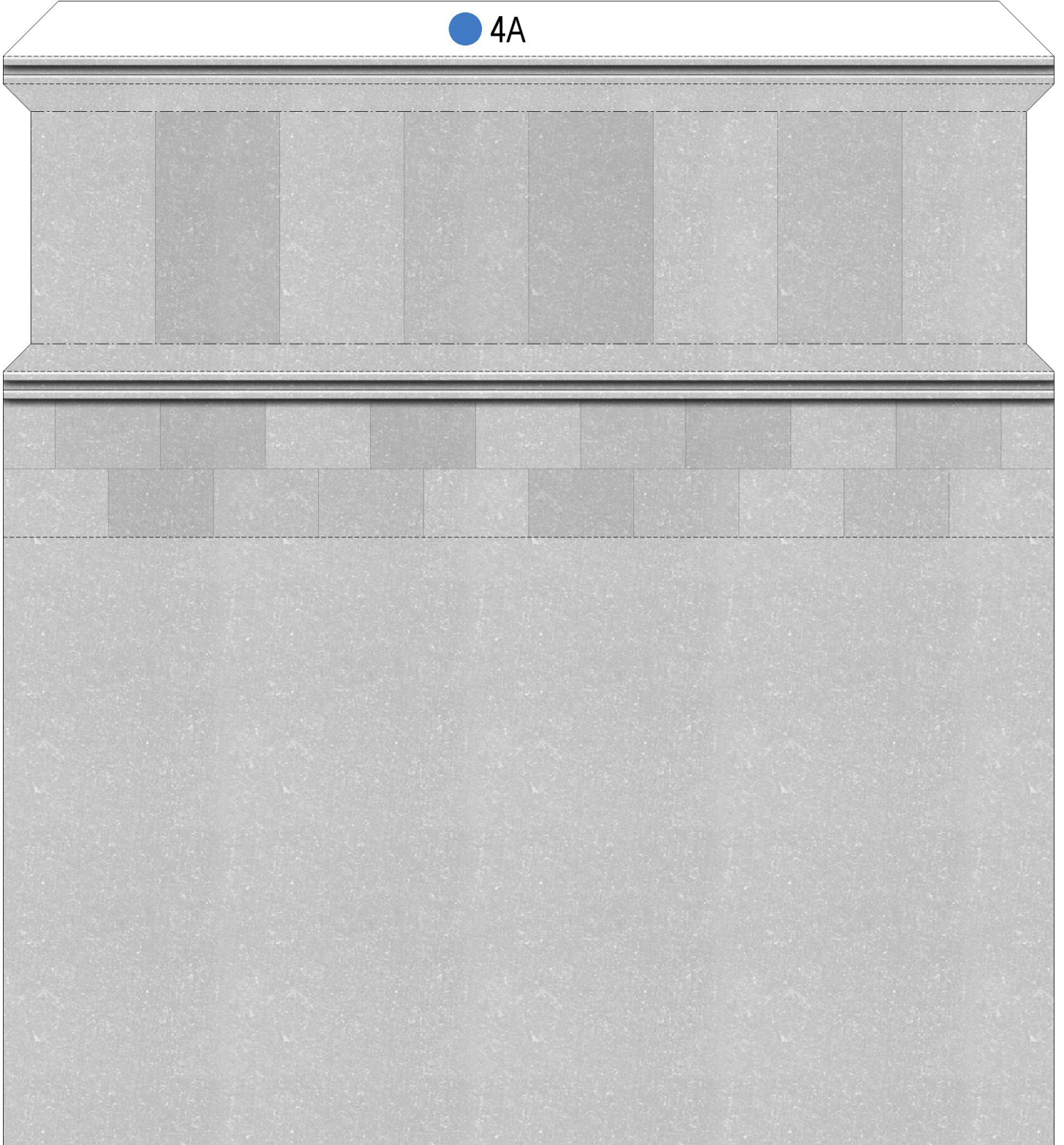

4B

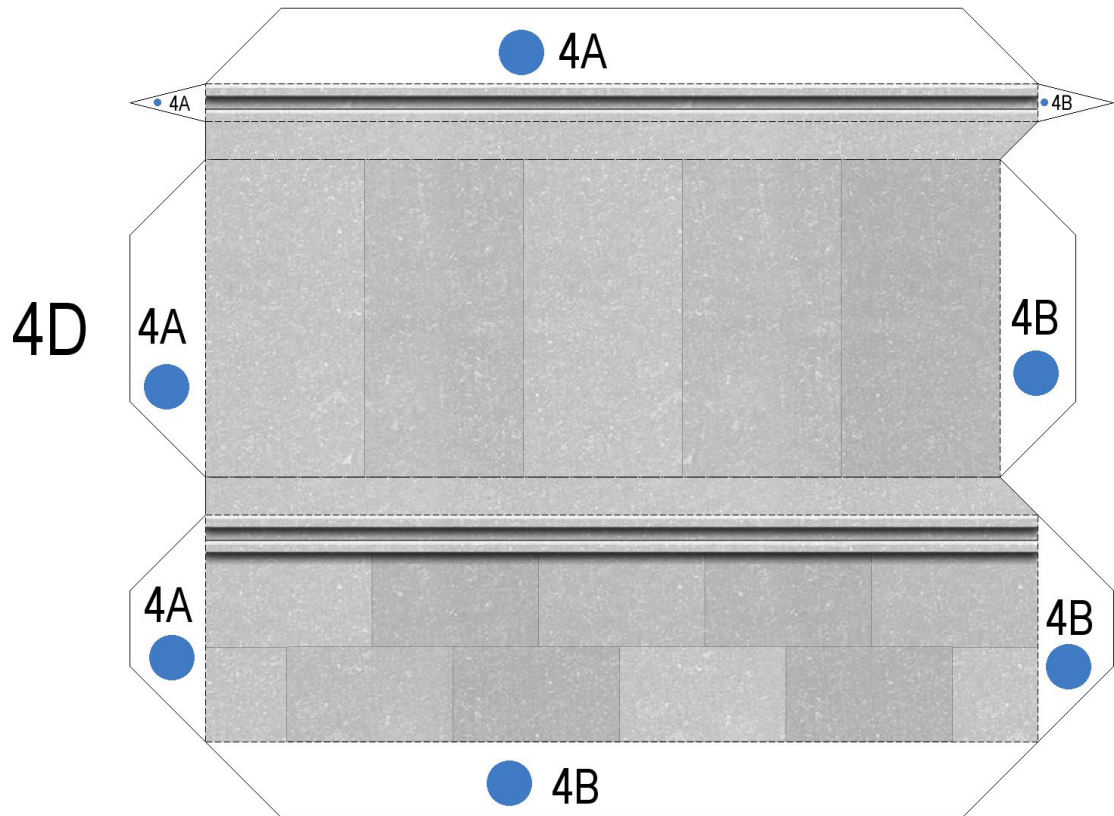
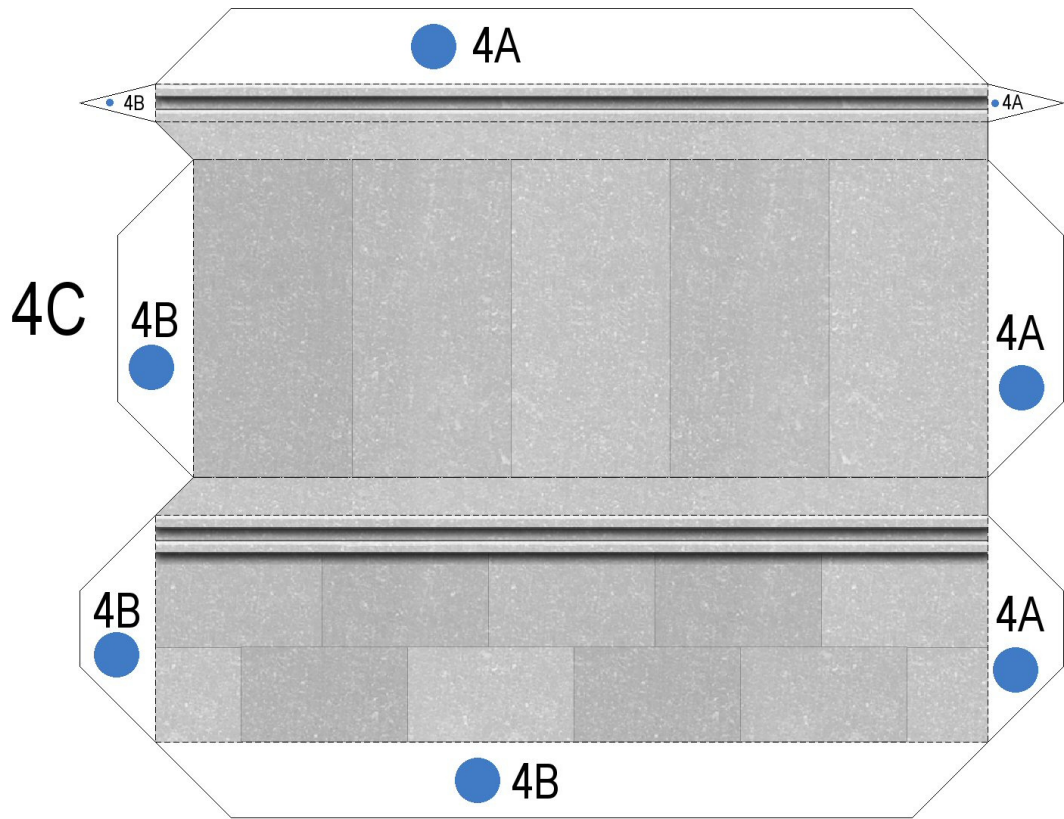

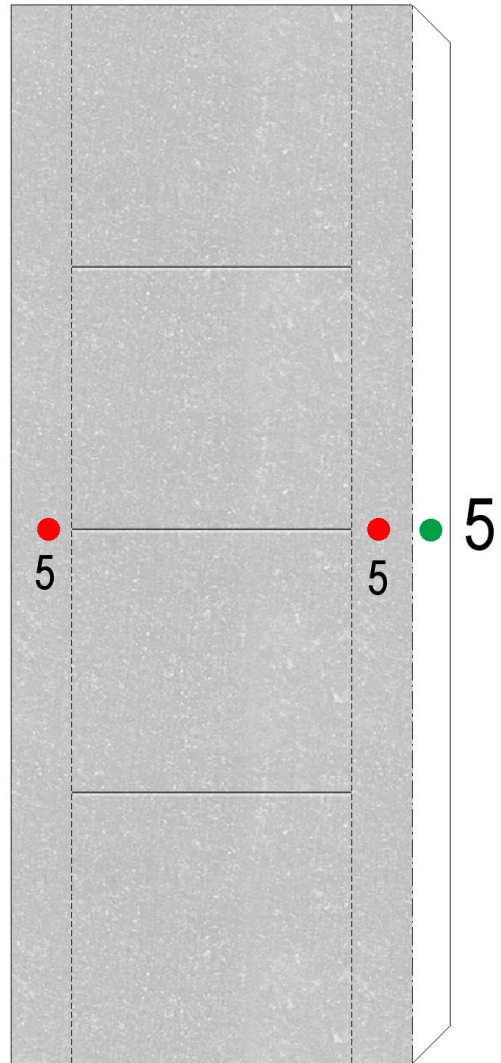
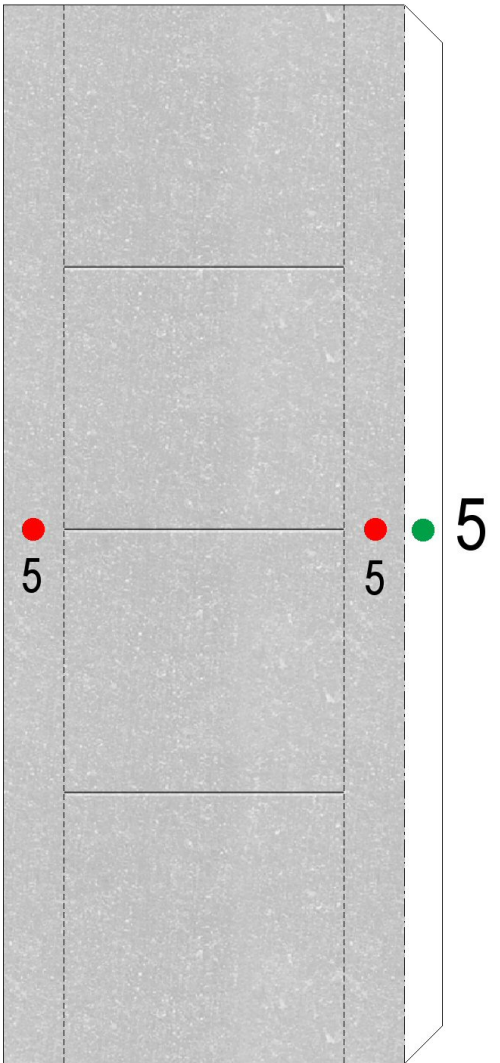
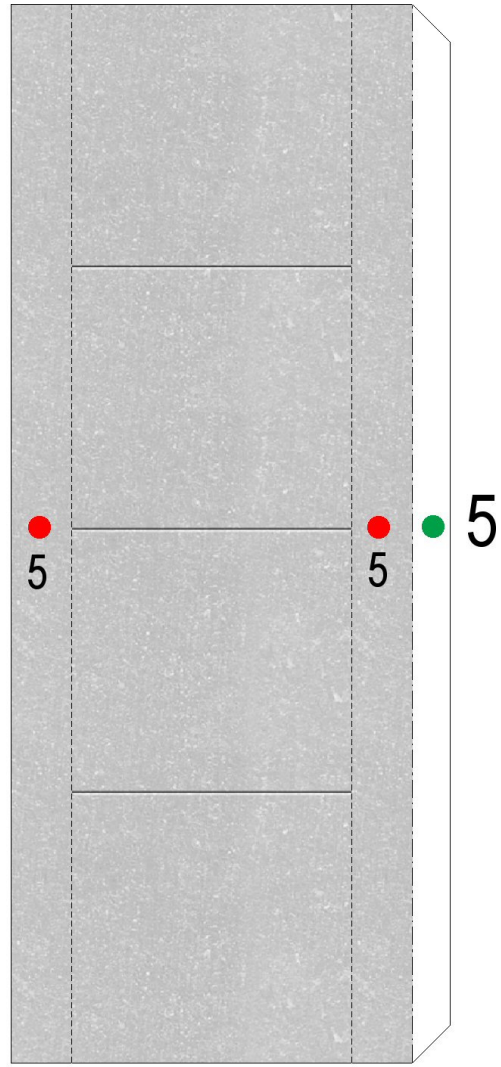
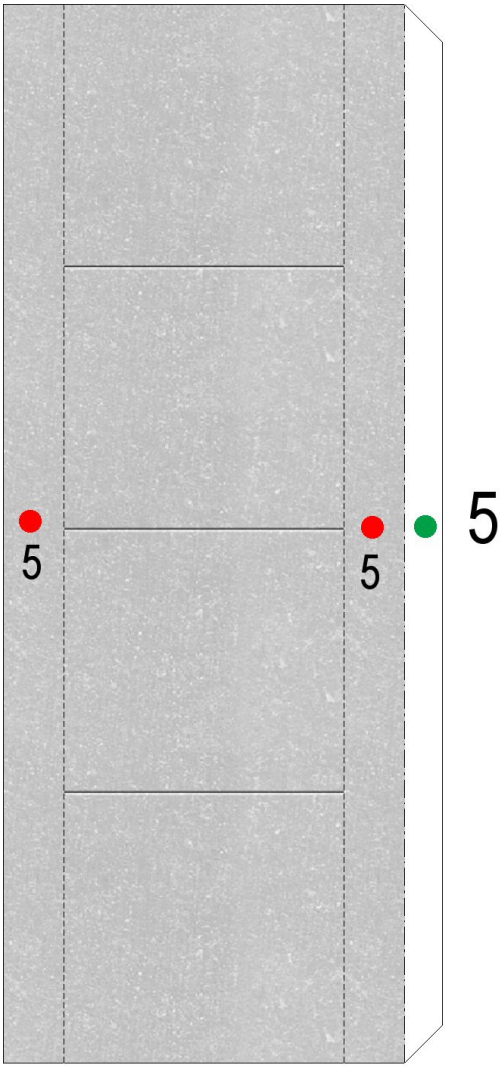

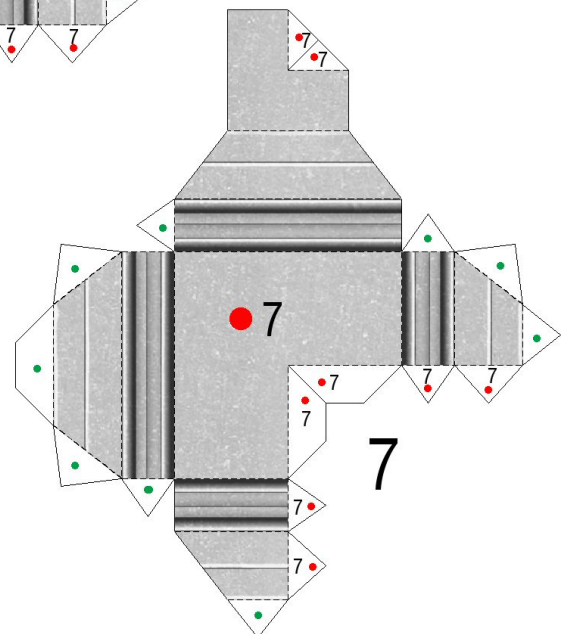
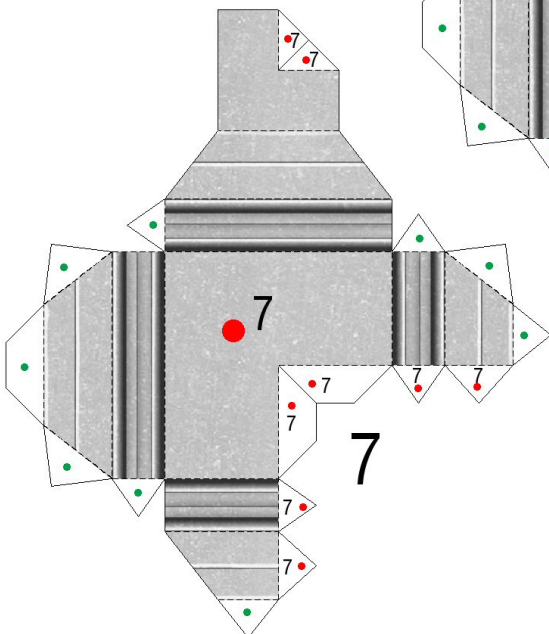
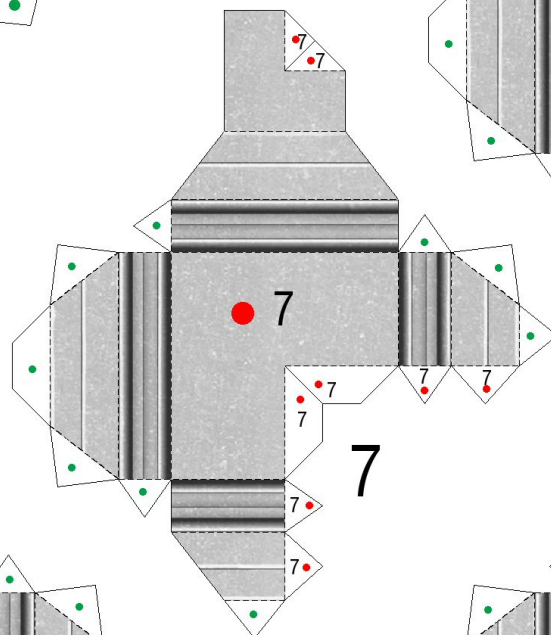
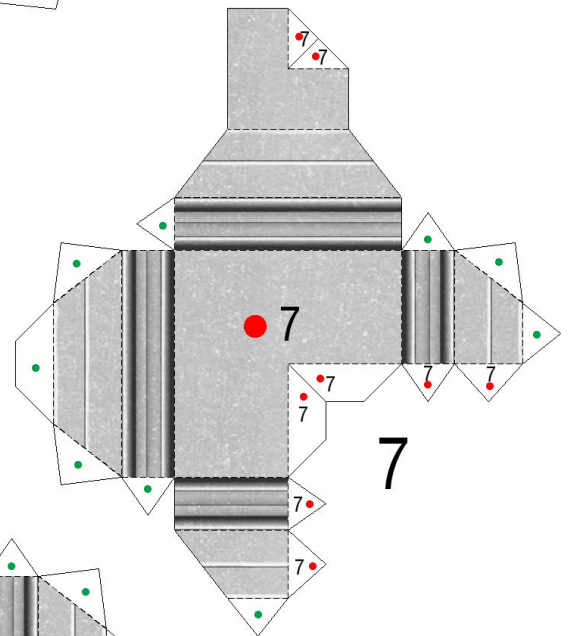
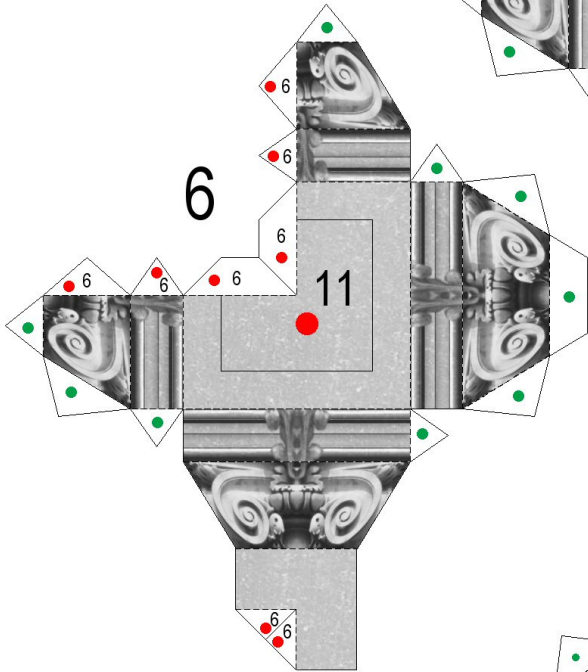
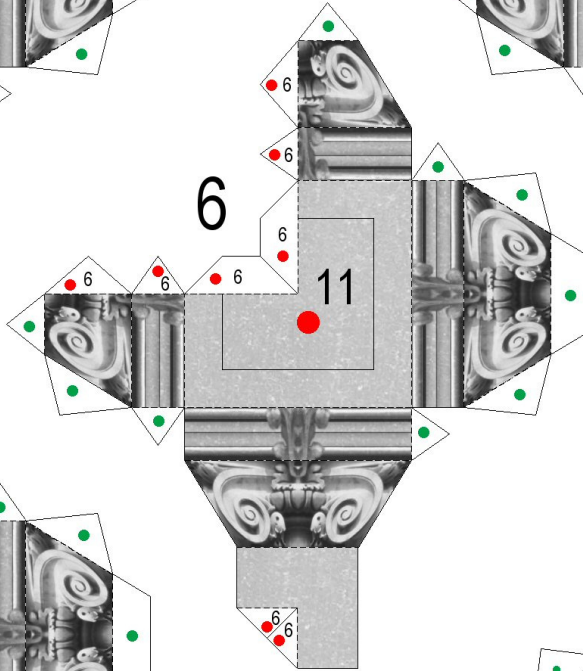
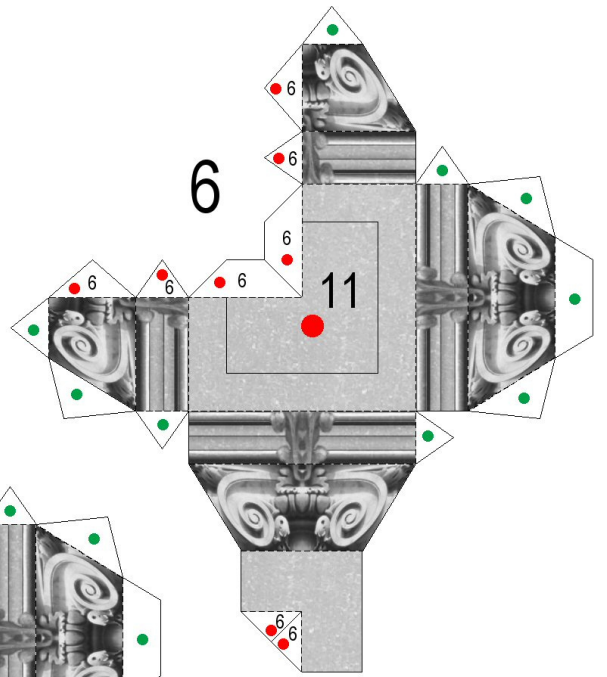
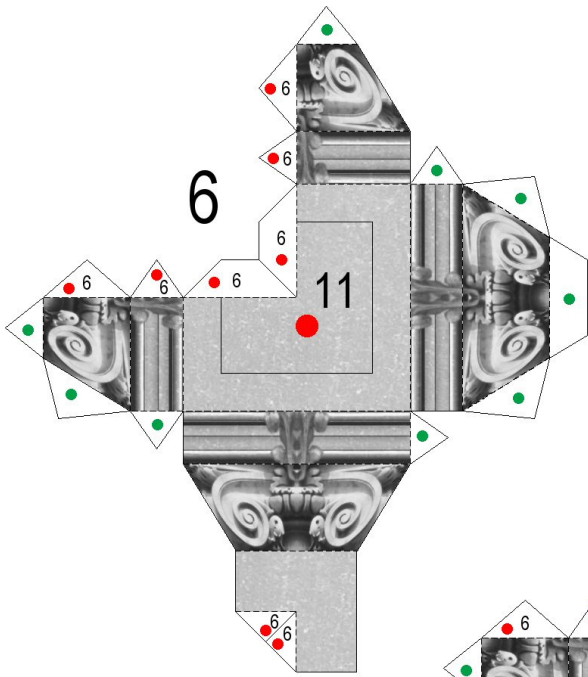

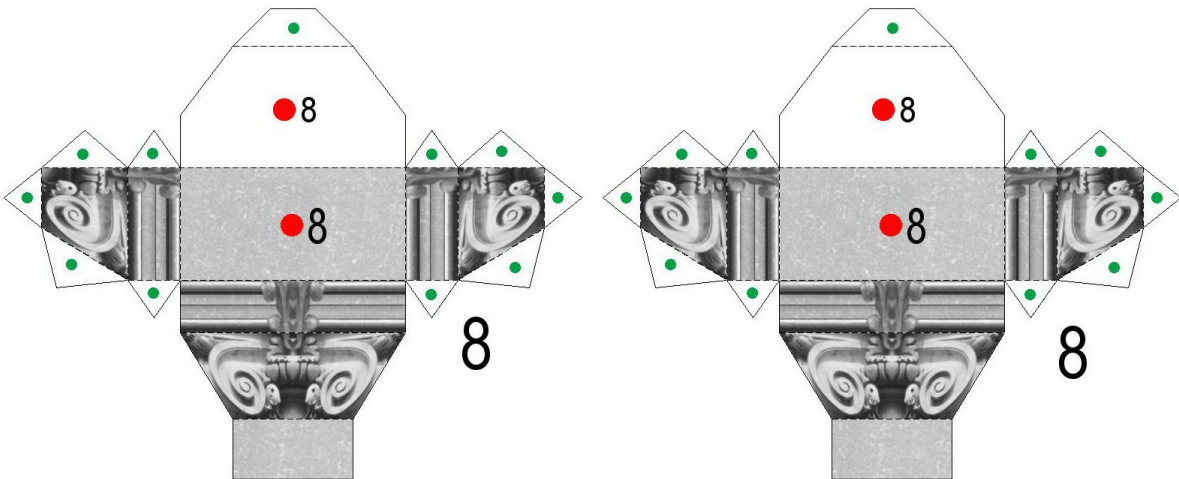
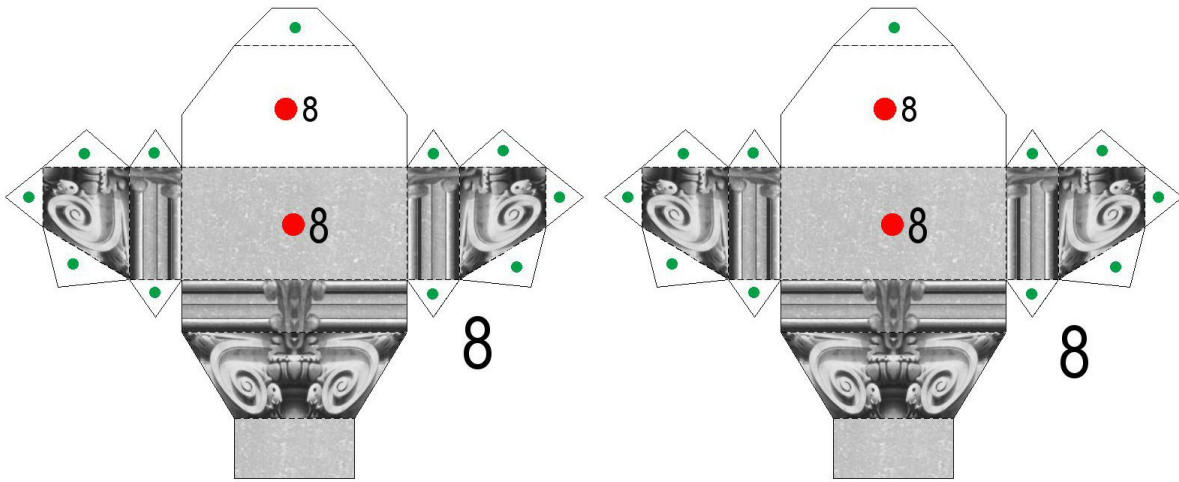
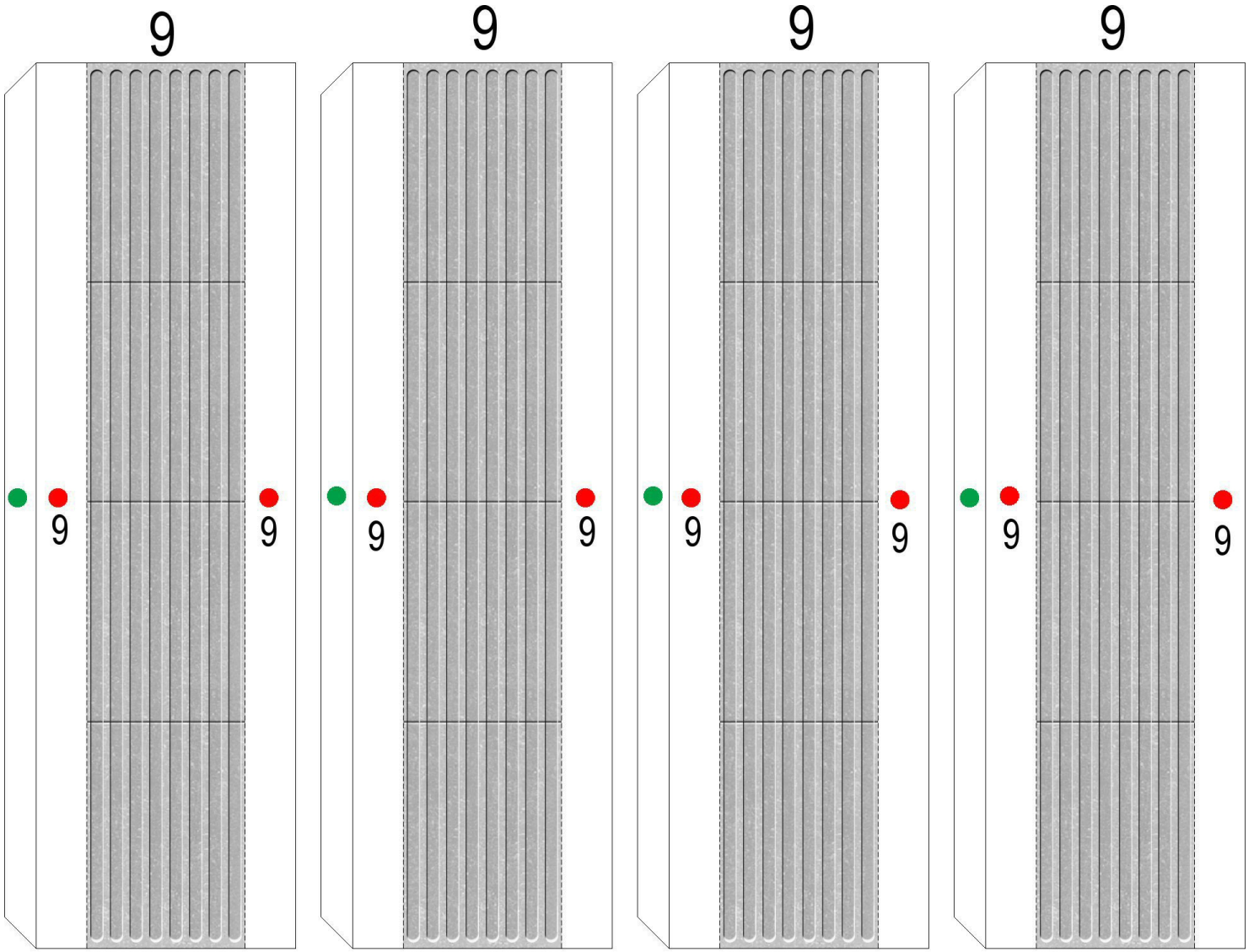

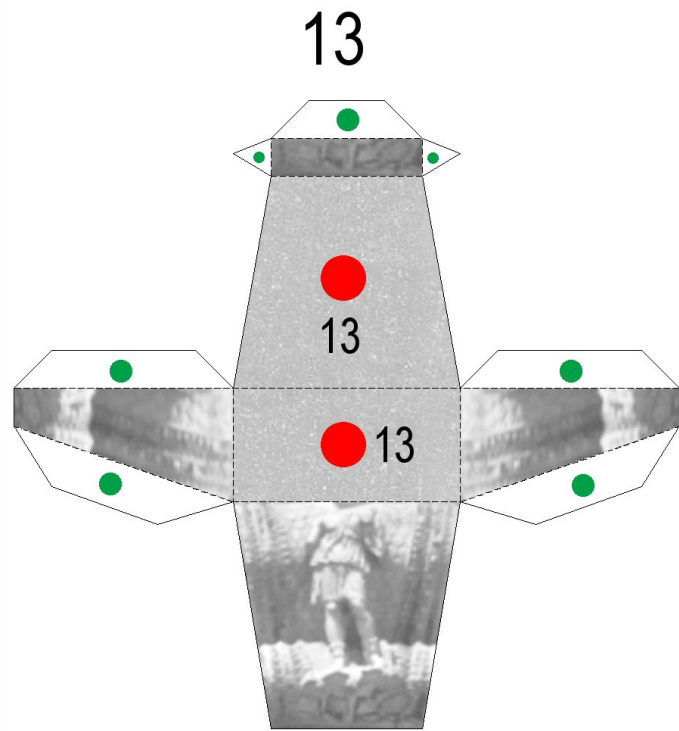
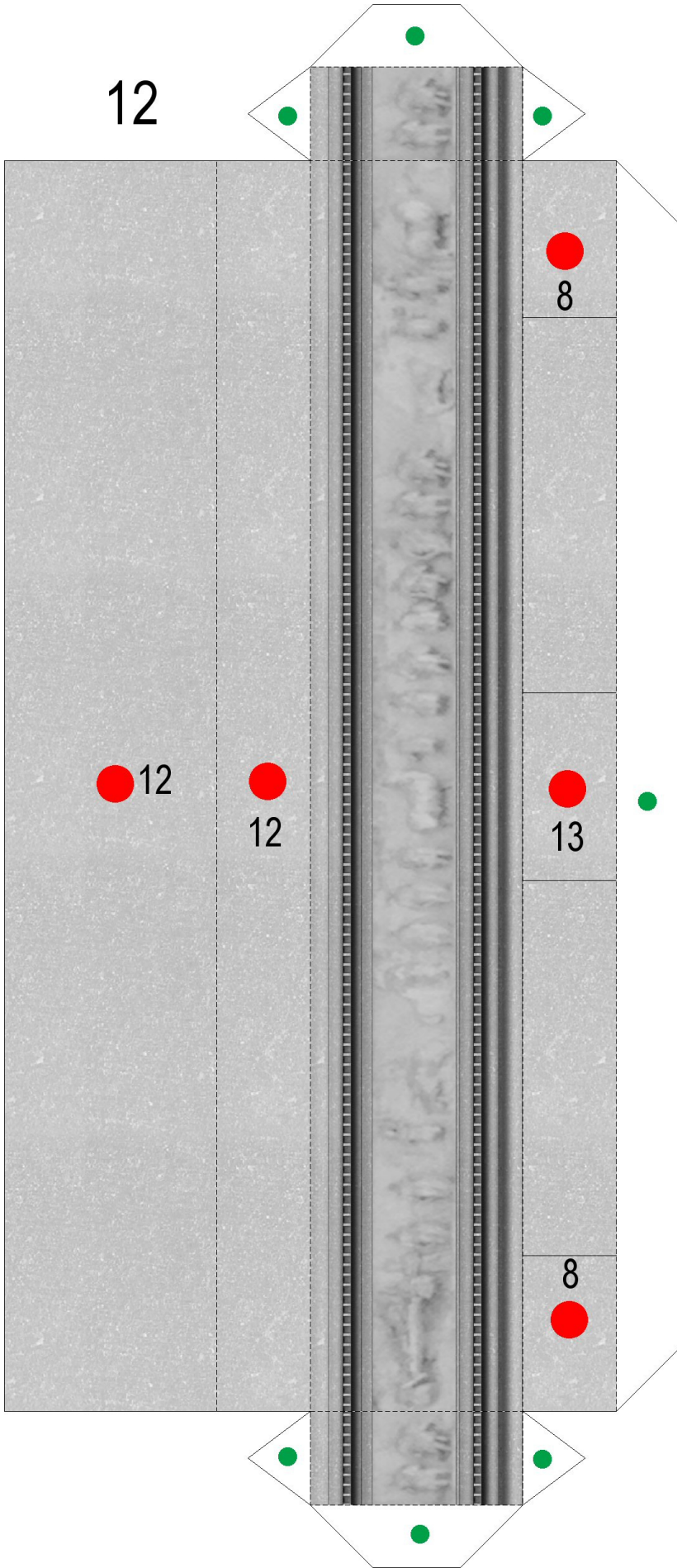

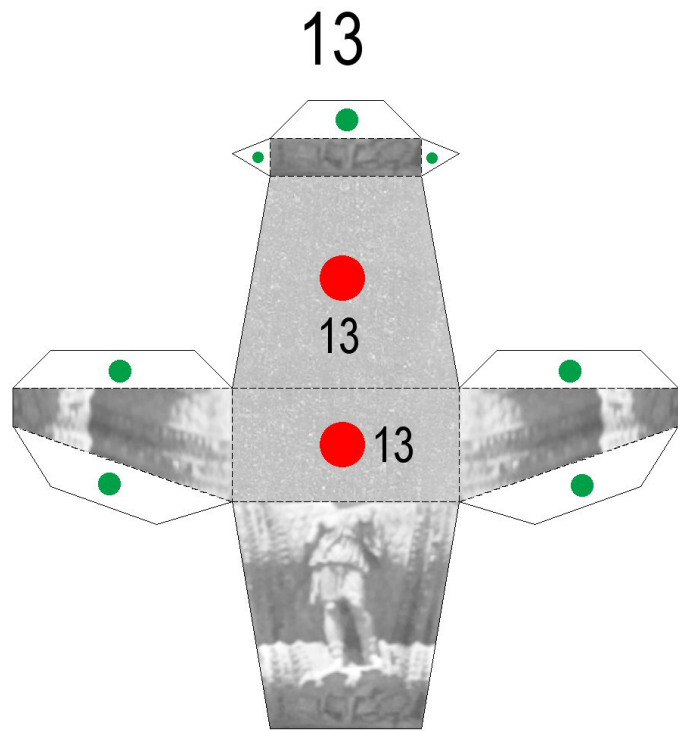
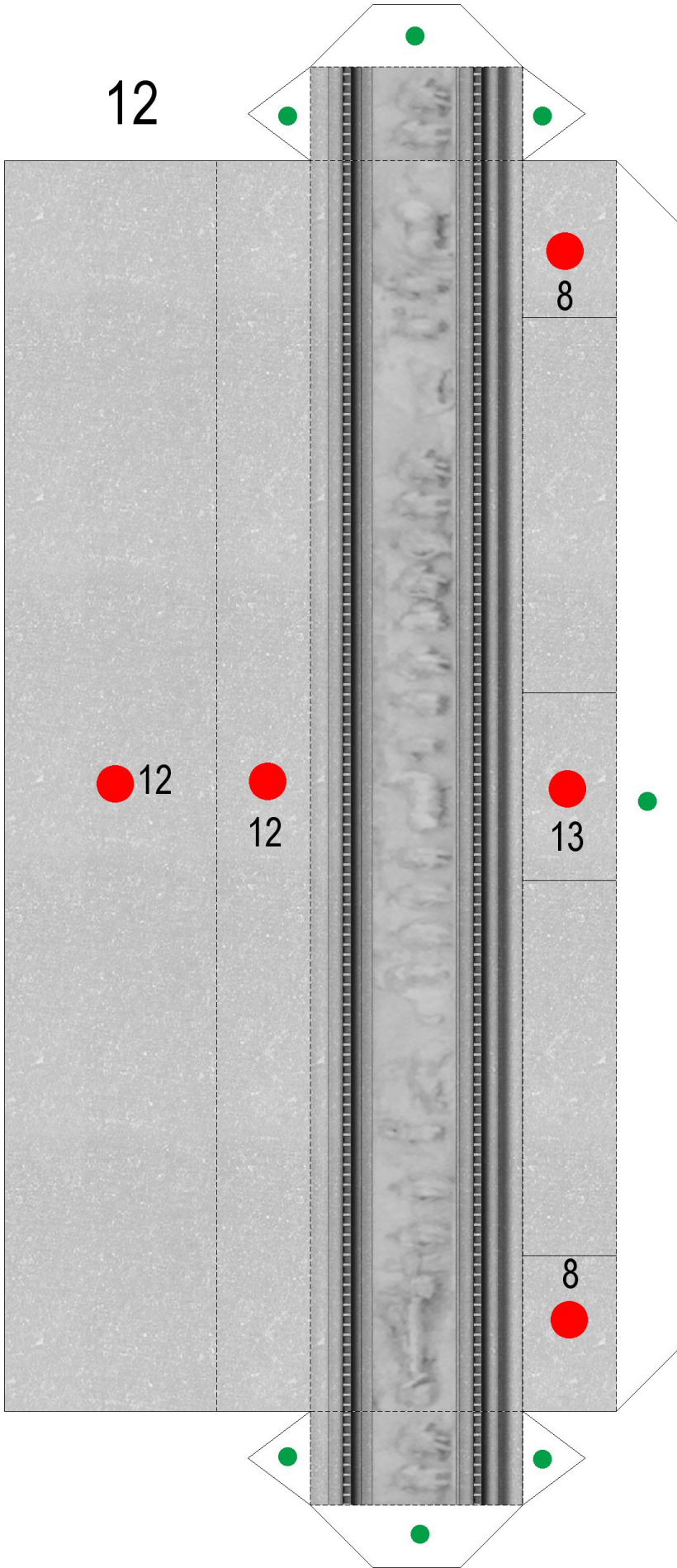

14A

● 14B

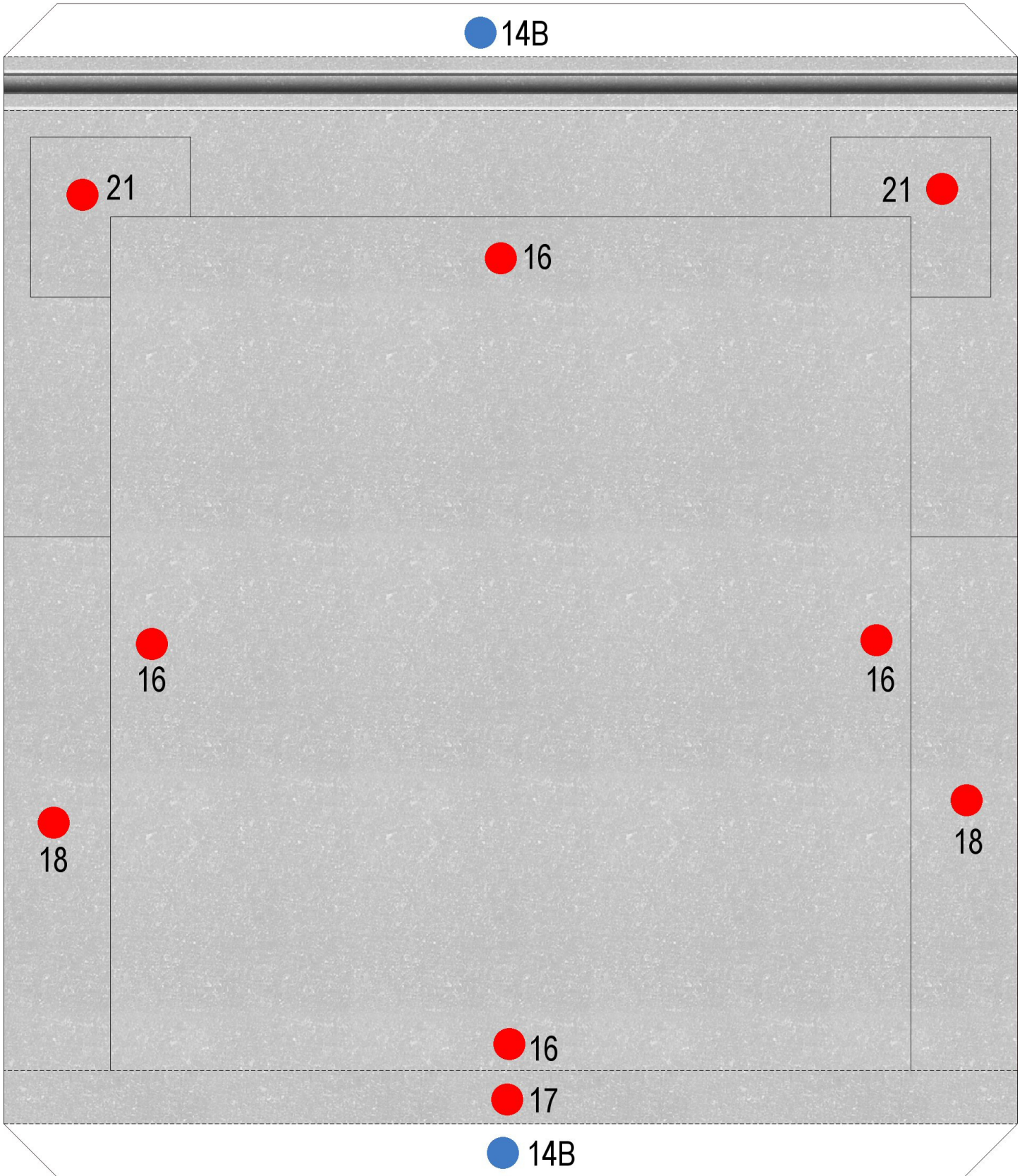

14B

● 14A

● 14A

14A ●

● 11

● 12

● 14

● 14

14 ●

● 11

● 14

● 12

● 14A

14A ●

● 14A

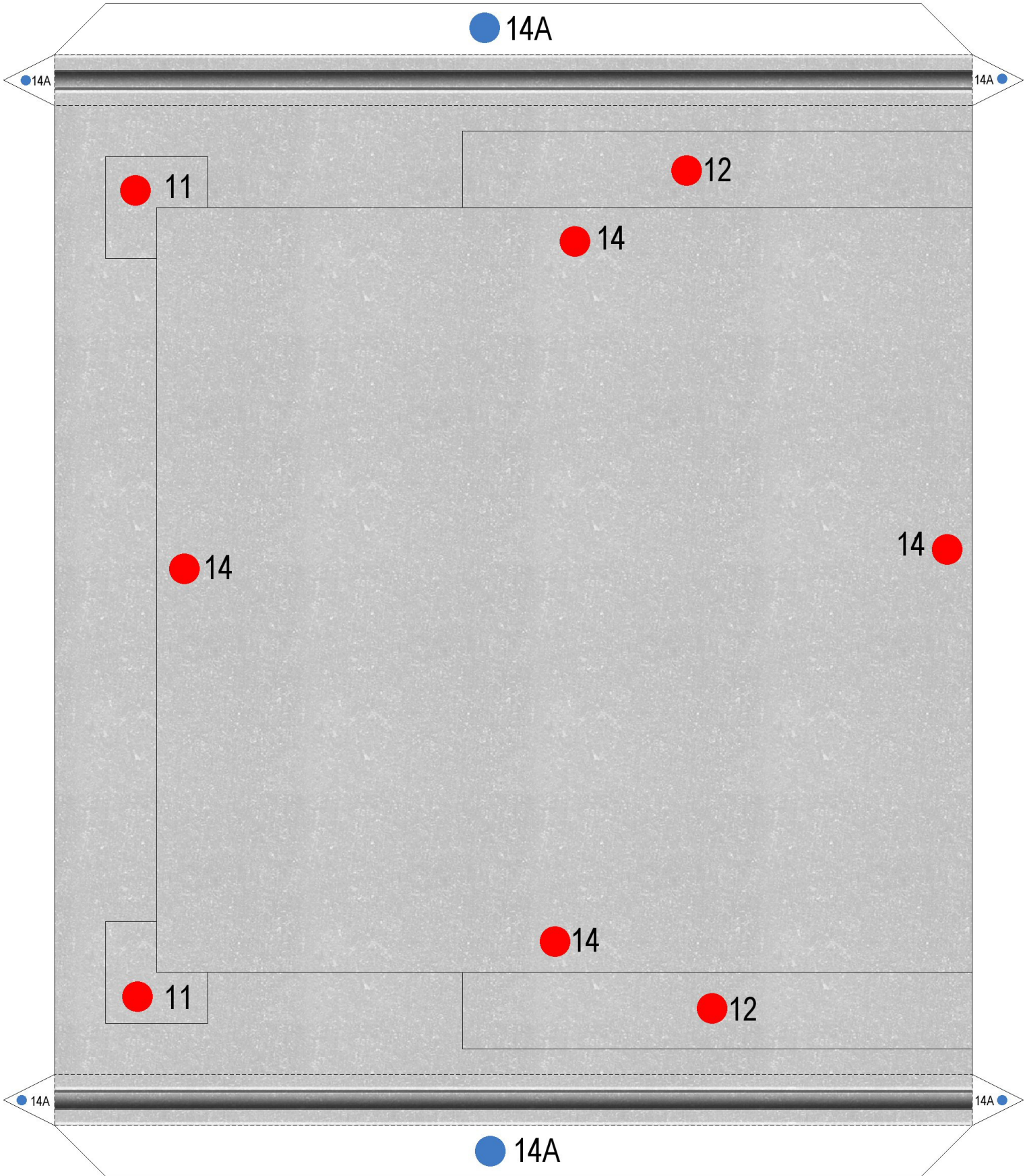

15A

● 15B

● 21

21 ●

● 17

● 17

● 17

● 18

● 18

● 17

● 17

● 15B

15B

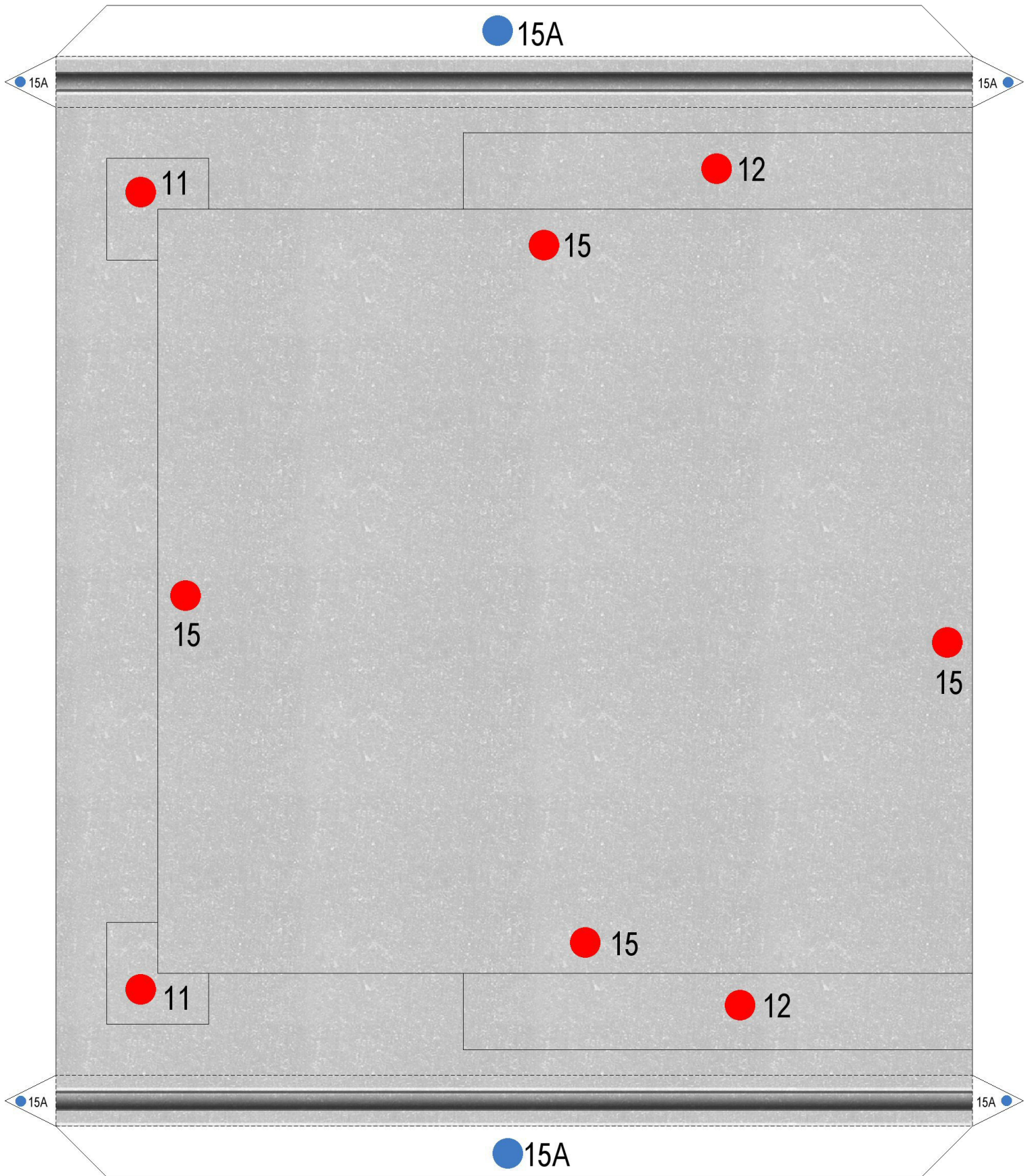

16A

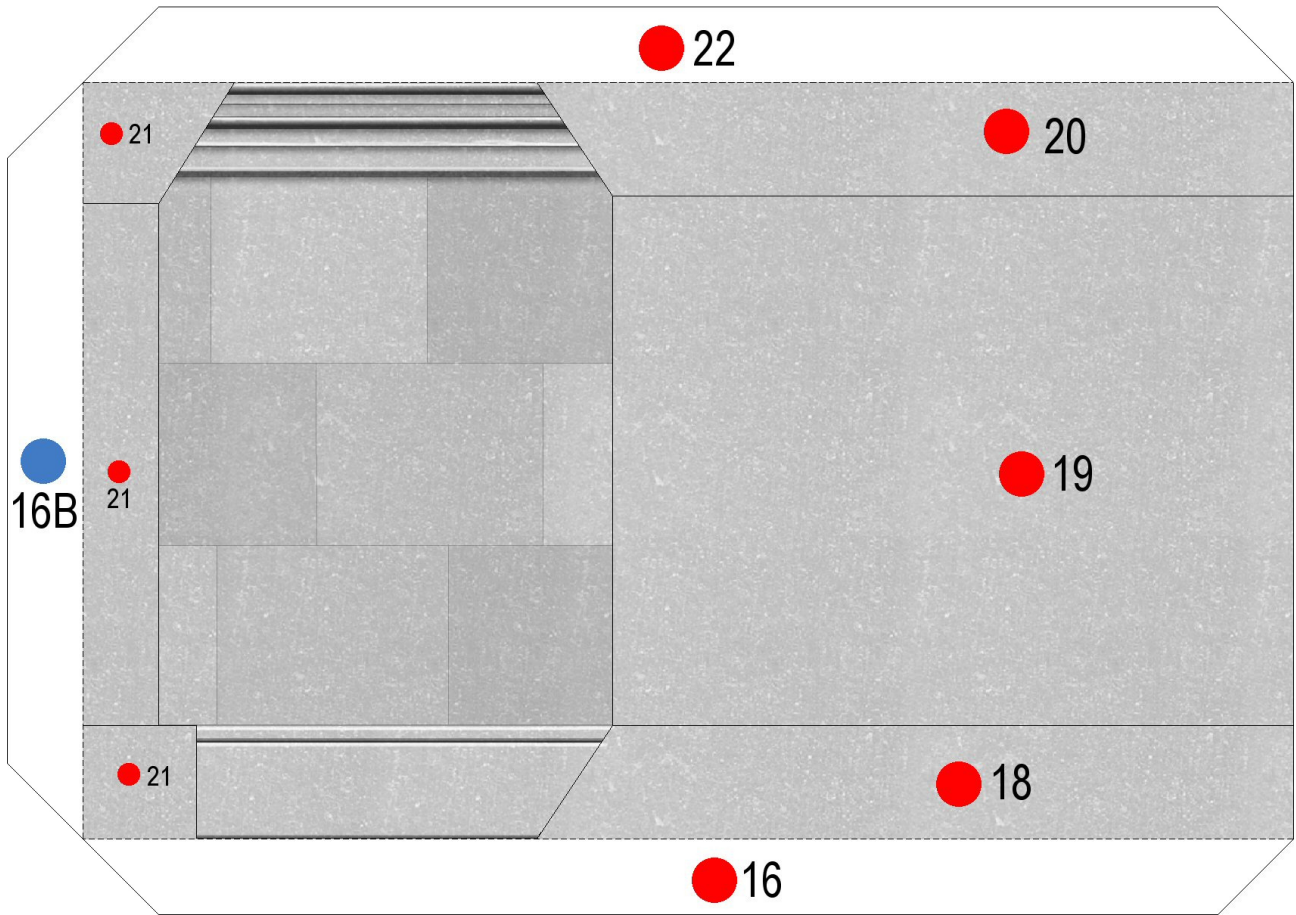

16B

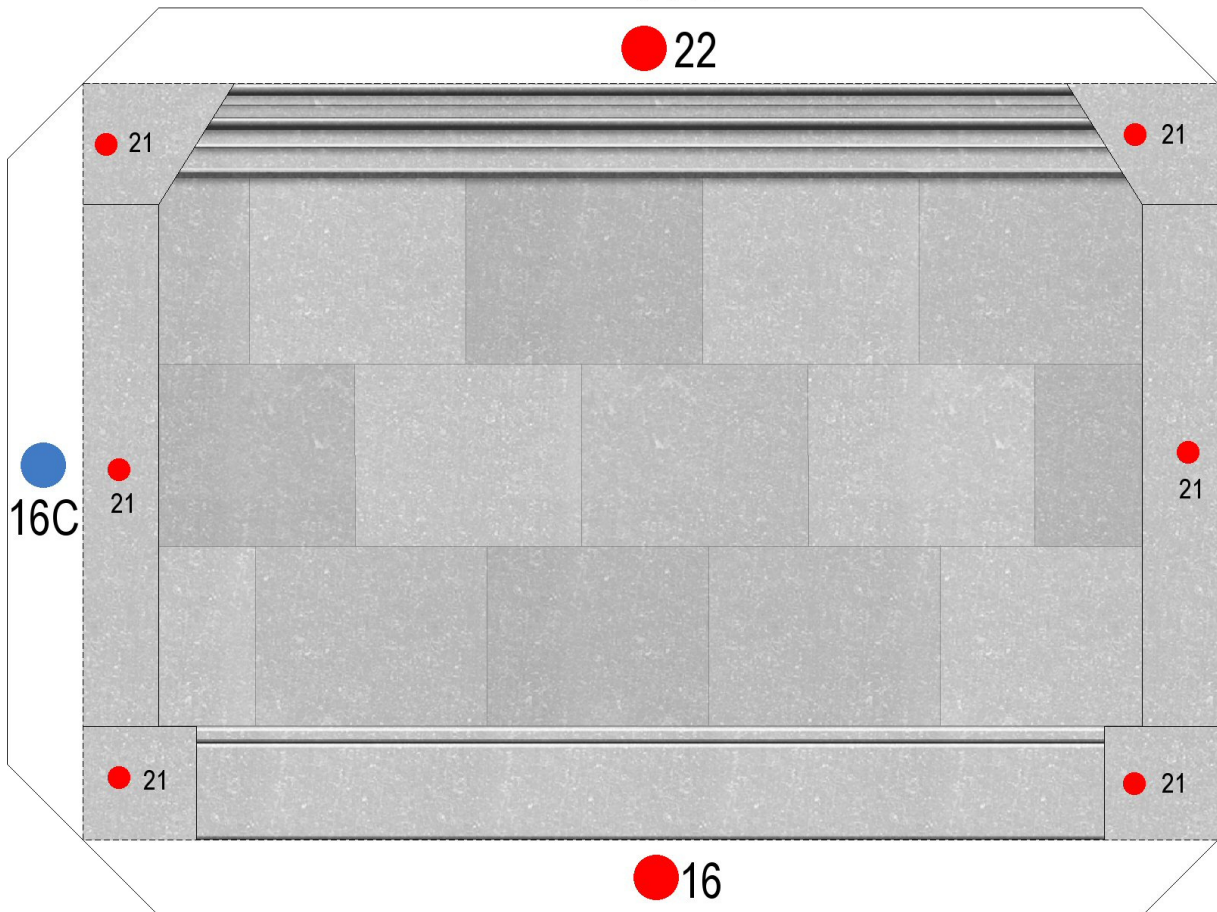

16C

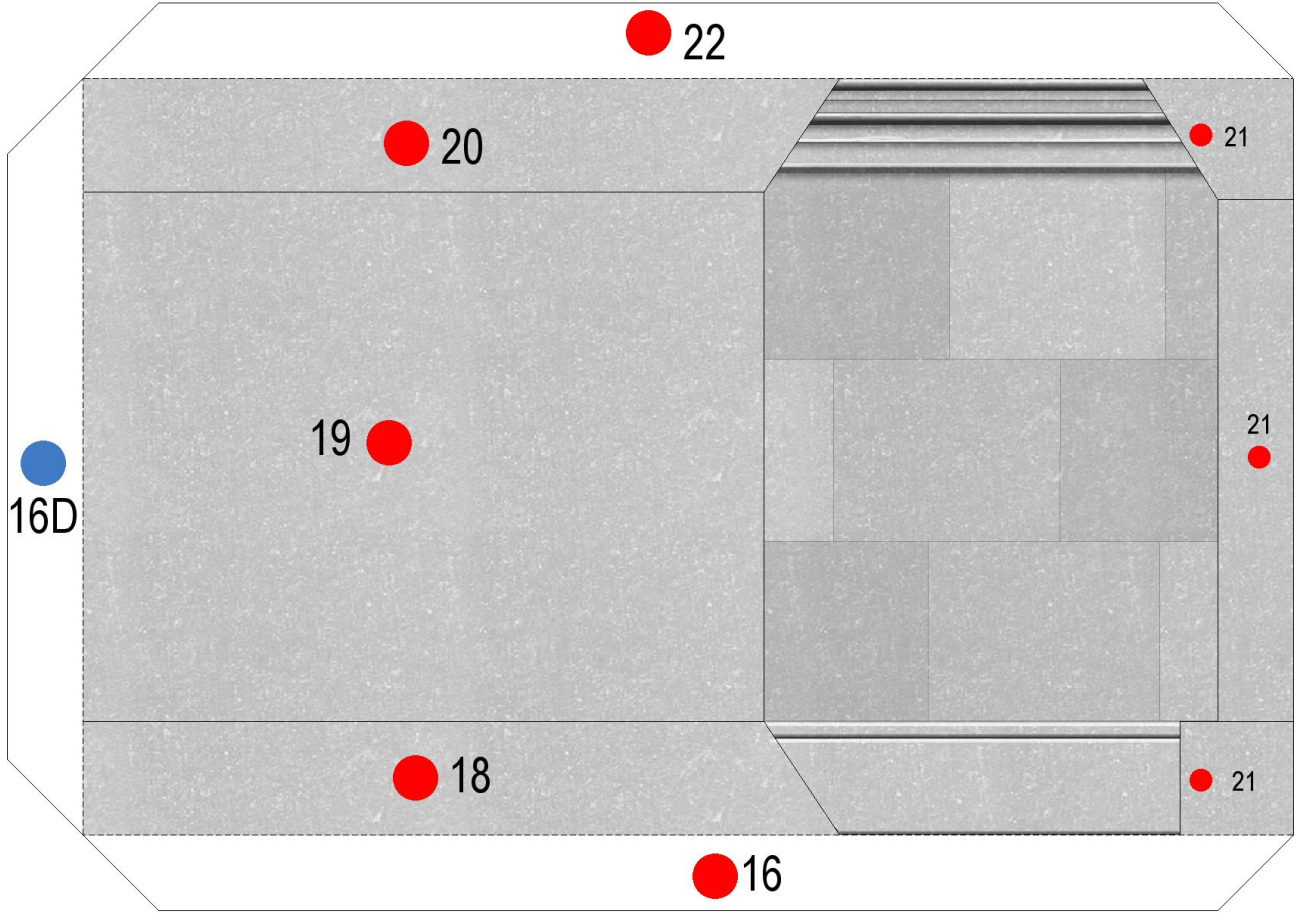

16D

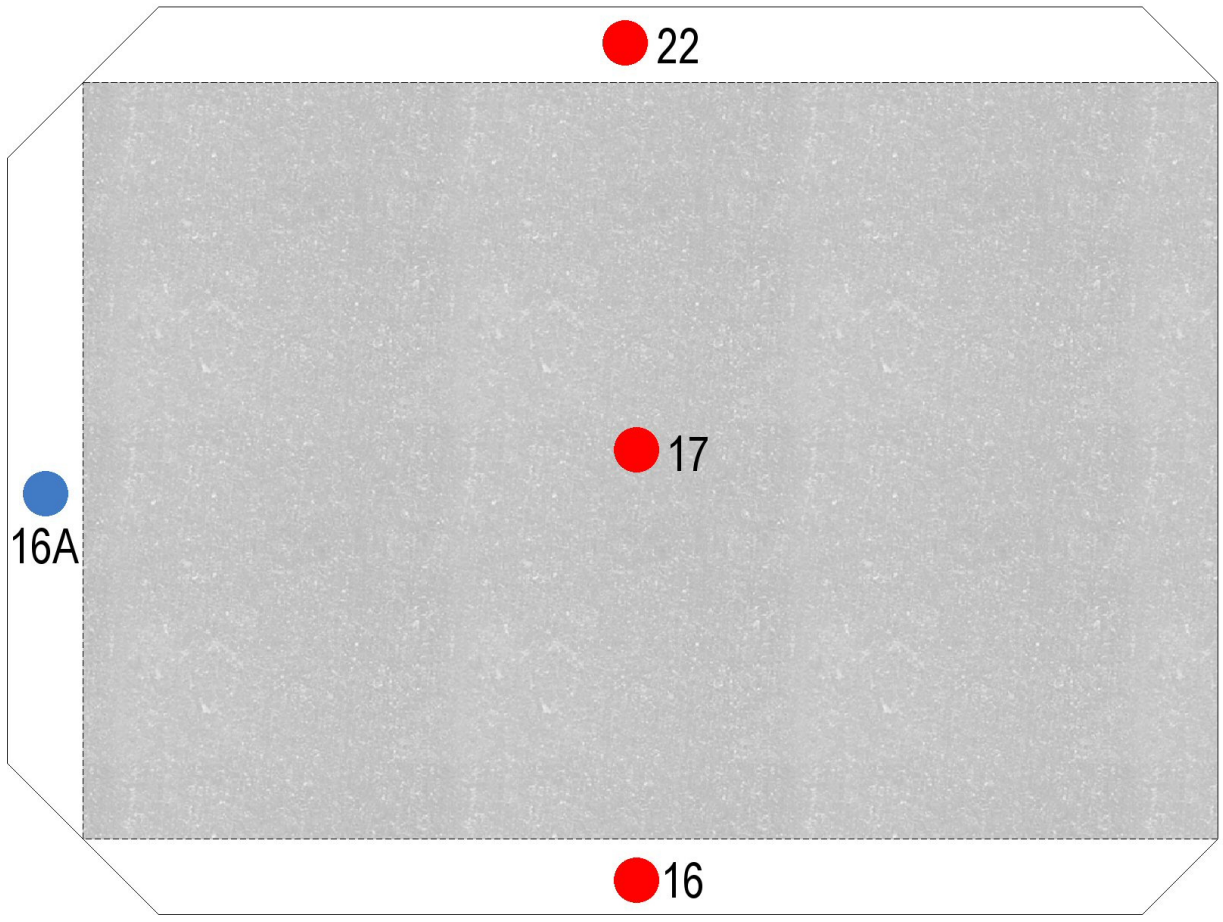

17A

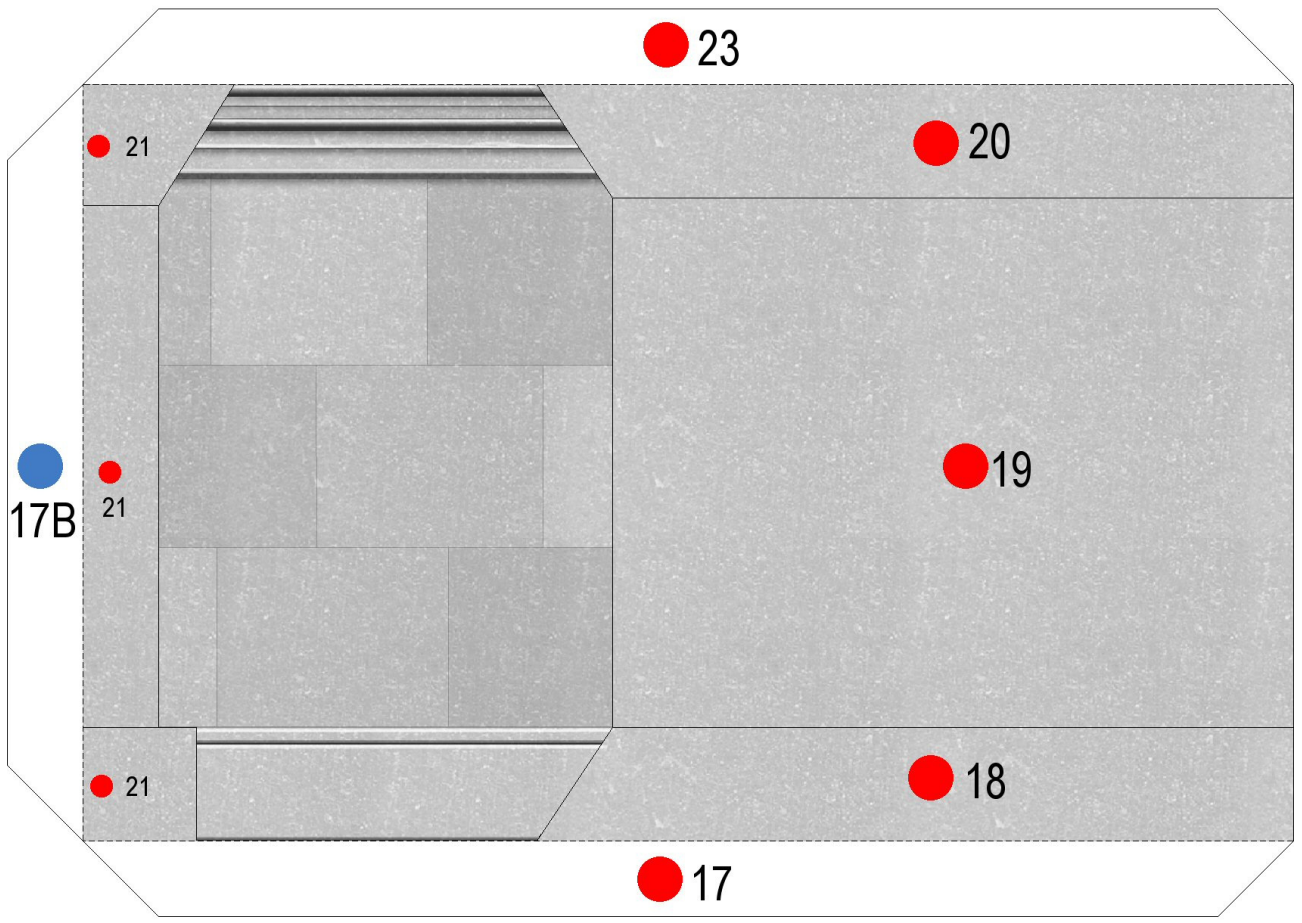

17B

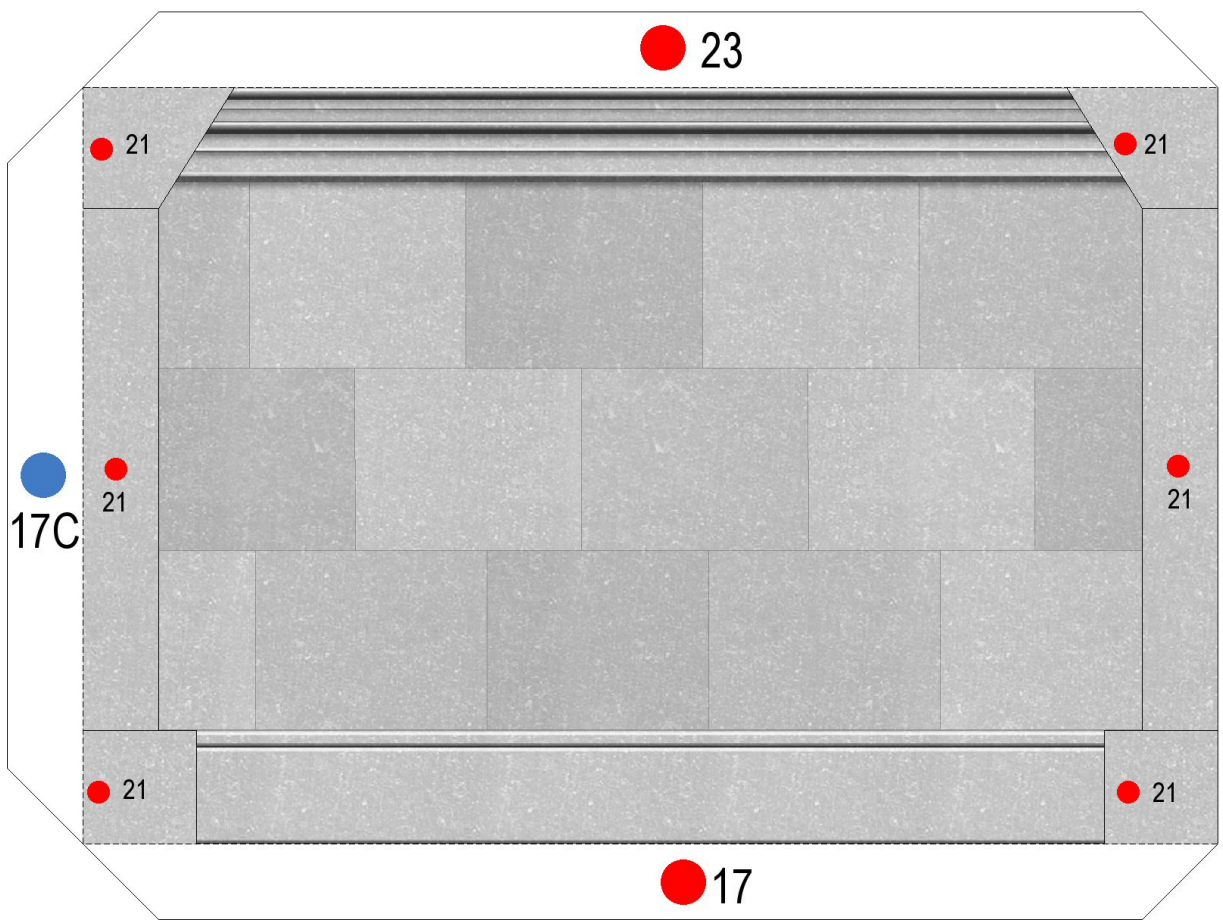

17C

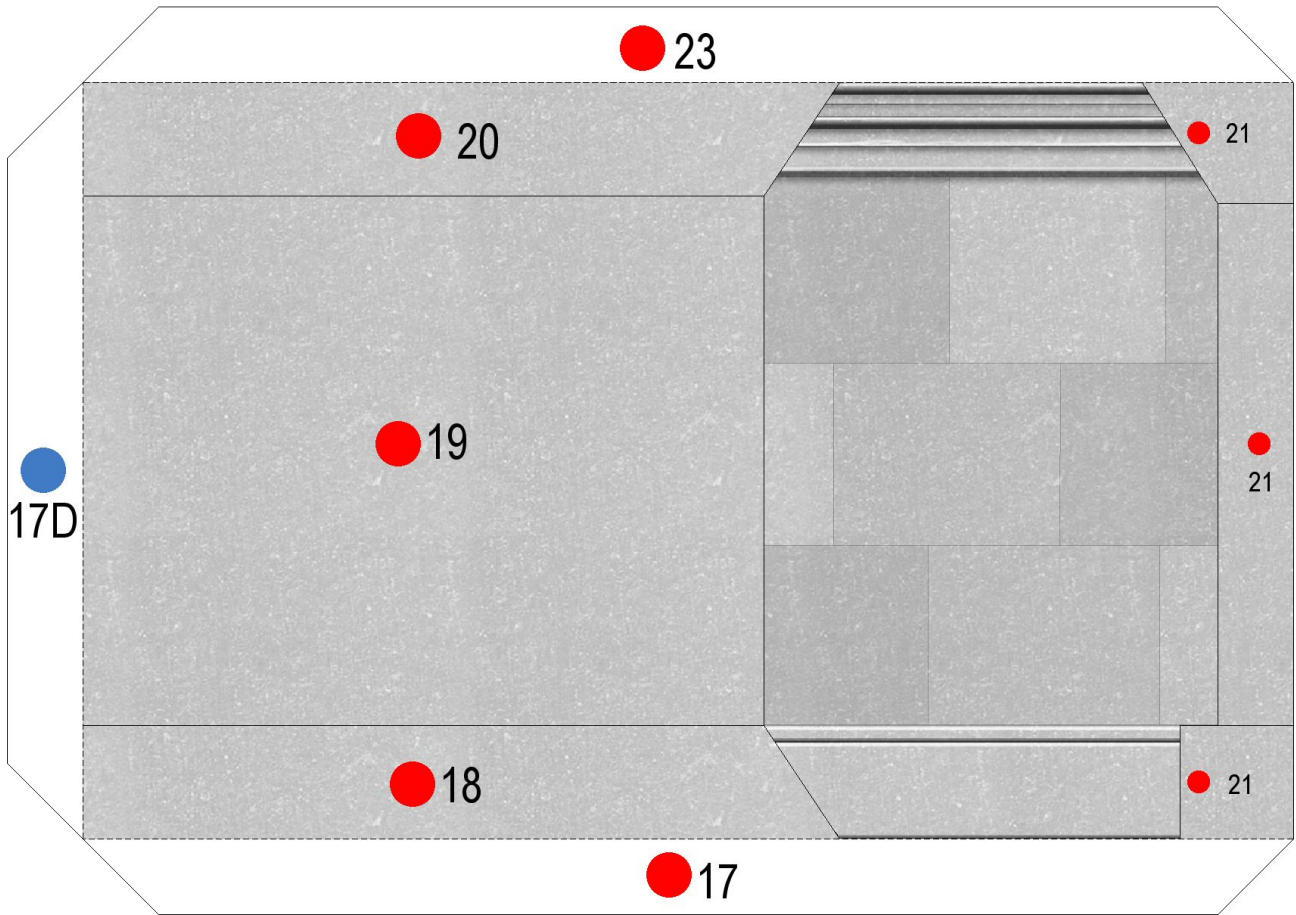

17D

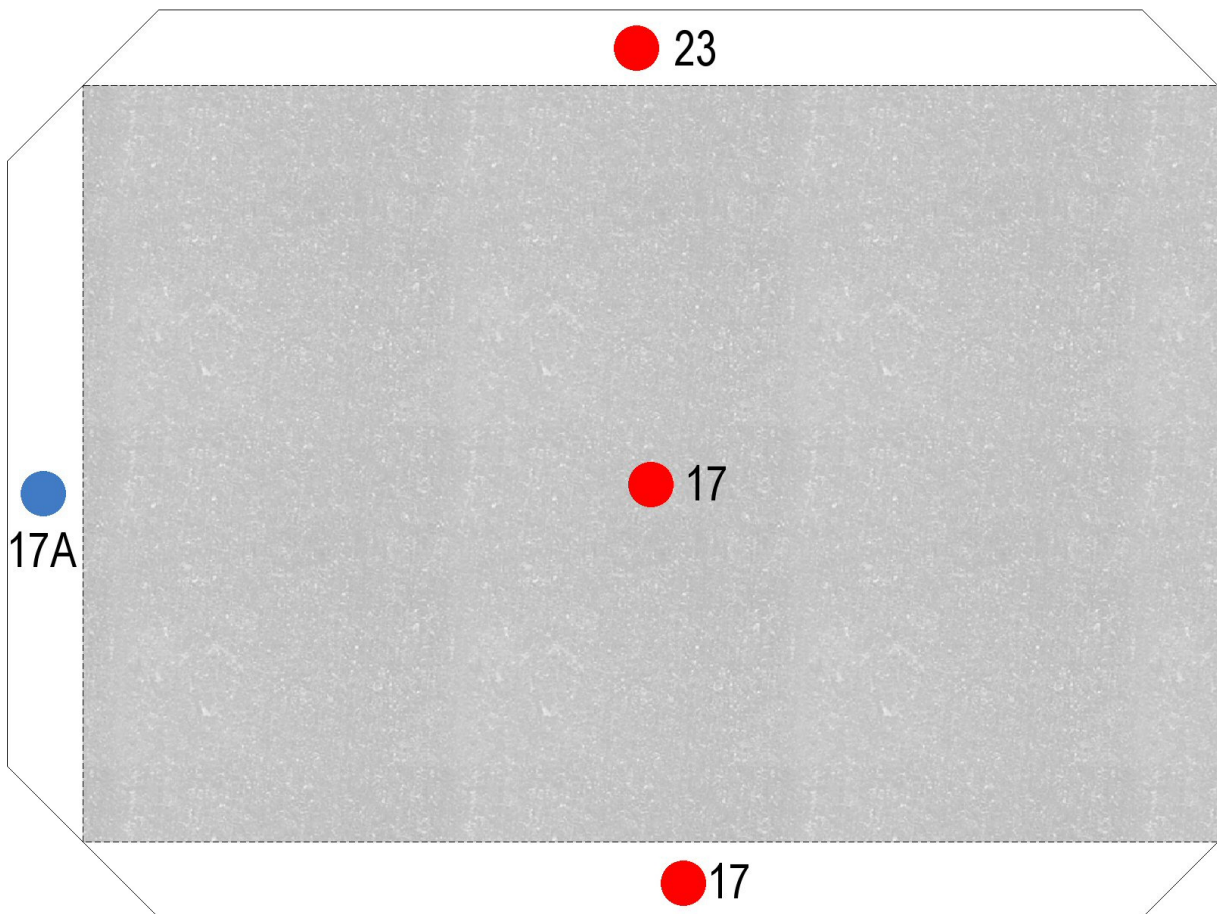

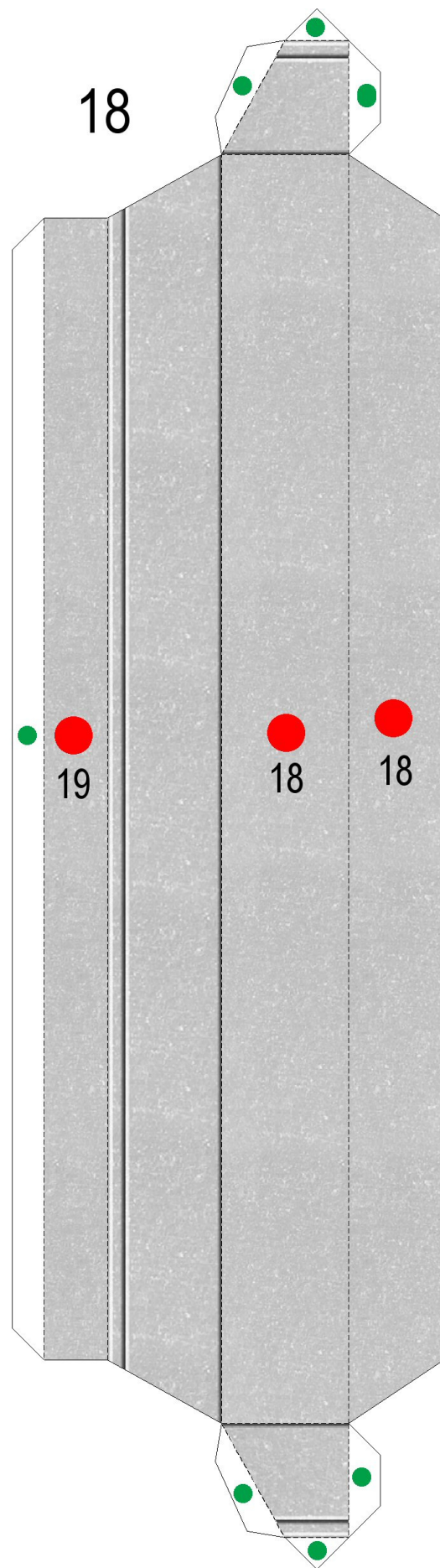
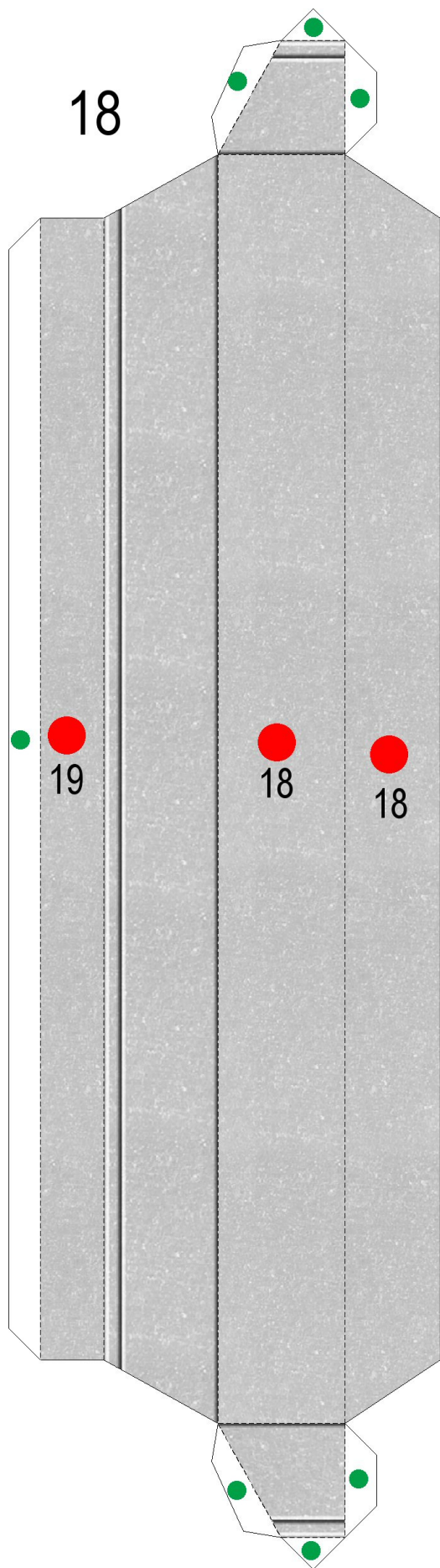

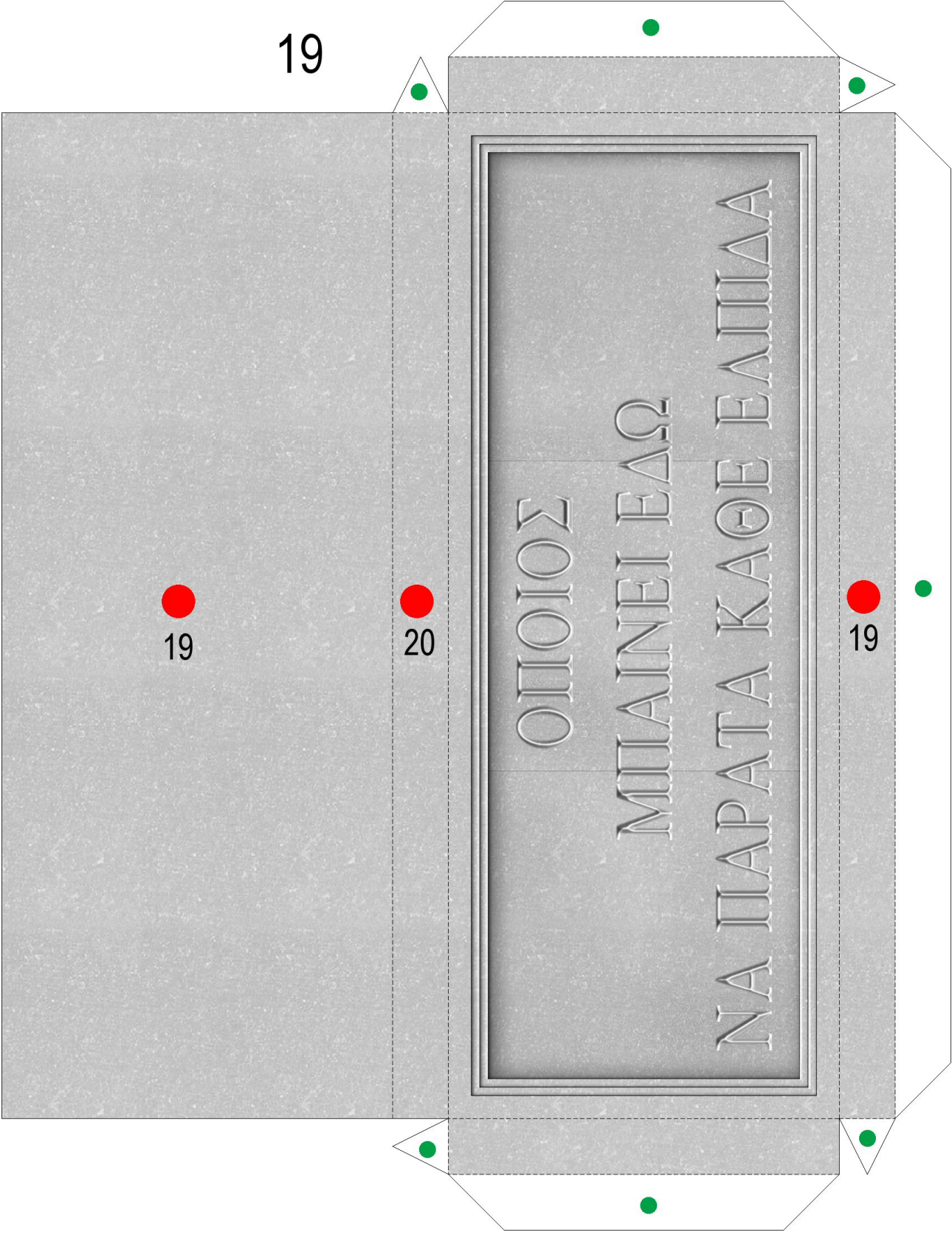

19

19

20

19

ΟΠΟΙΟΣ
ΜΠΙΝΕΙ ΕΔΩ
ΝΑ ΠΑΡΑΤΑ ΚΑΘΕ ΕΛΠΙΔΑ

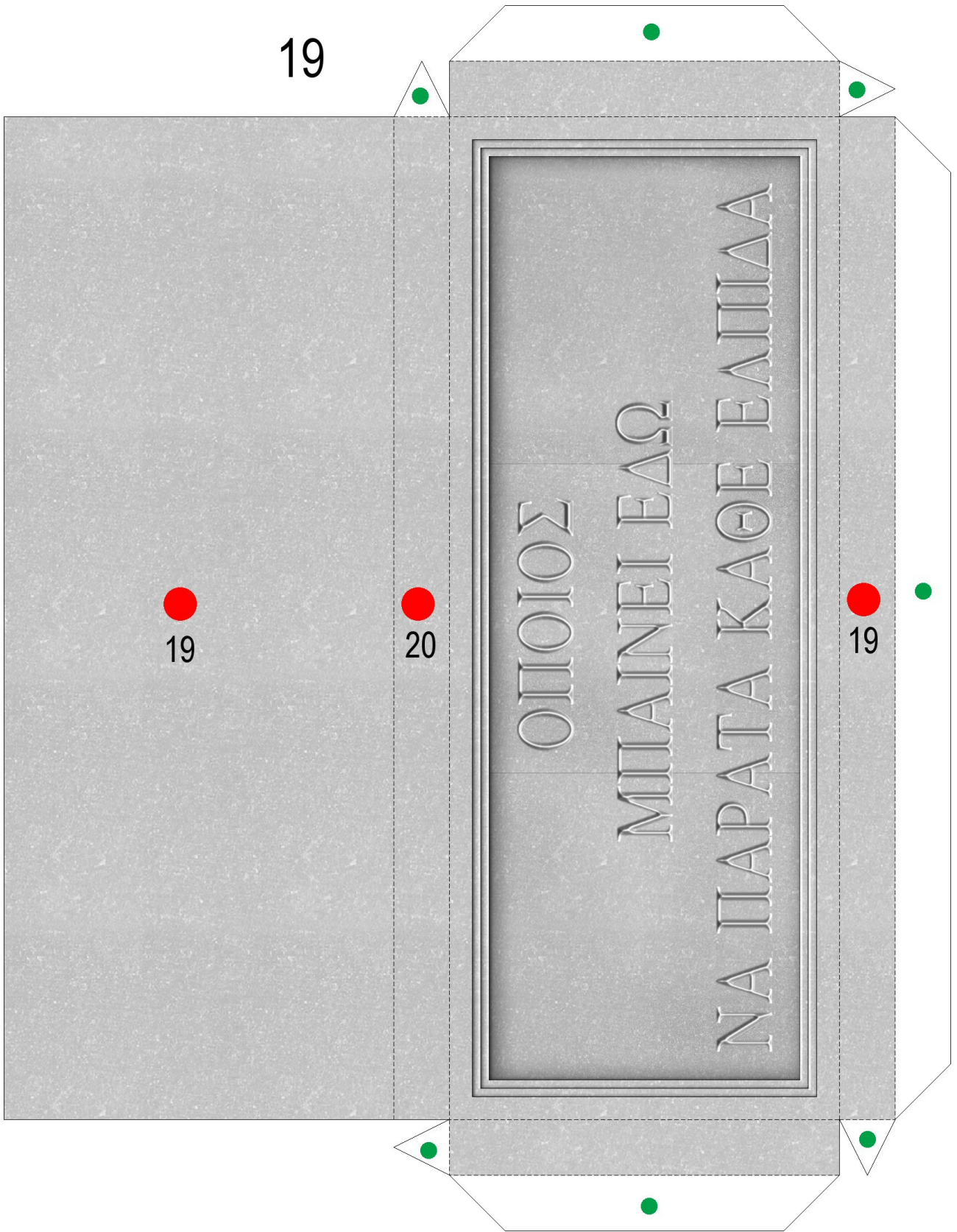

19

19

20

19

ΟΠΟΙΟΣ
ΜΠΙΛΙΝΕΙ ΕΔΩ
ΝΑ ΠΑΡΑΤΑ ΚΑΘΕ ΕΛΠΙΔΑ

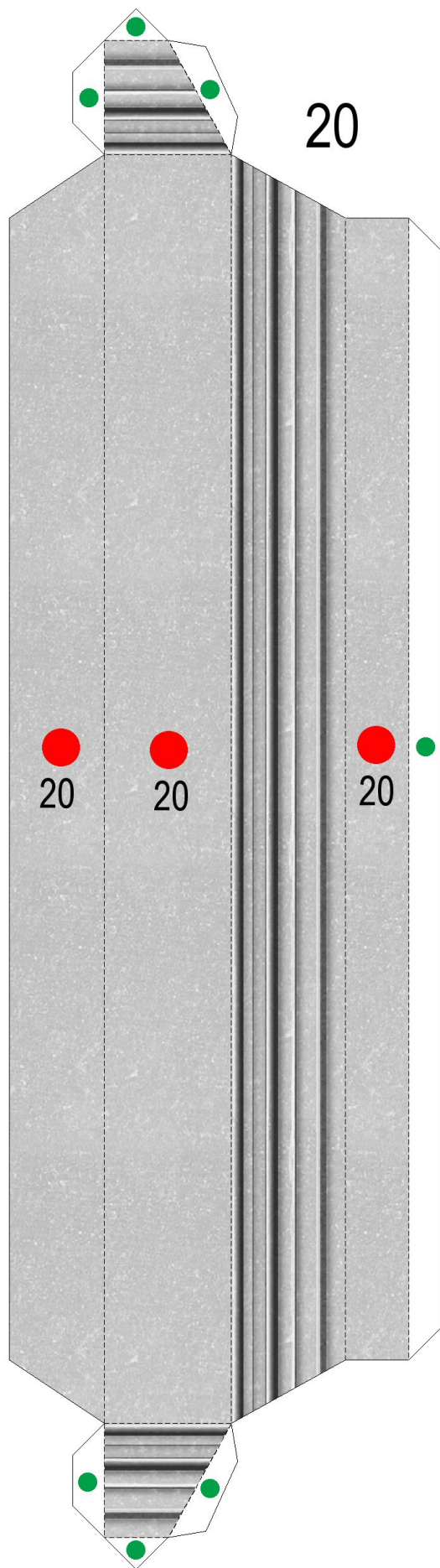
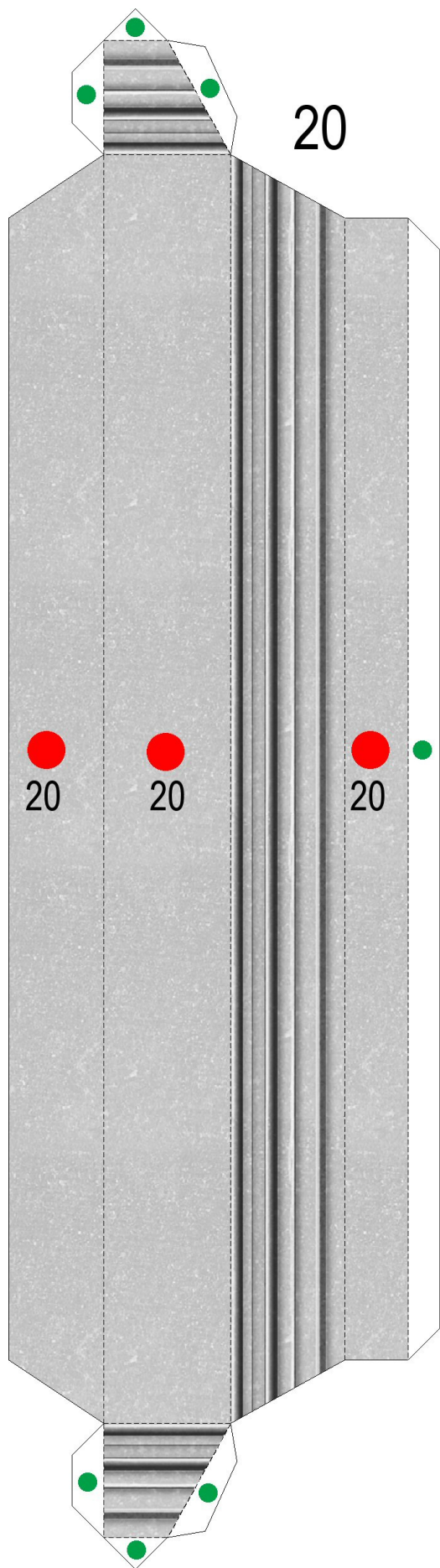

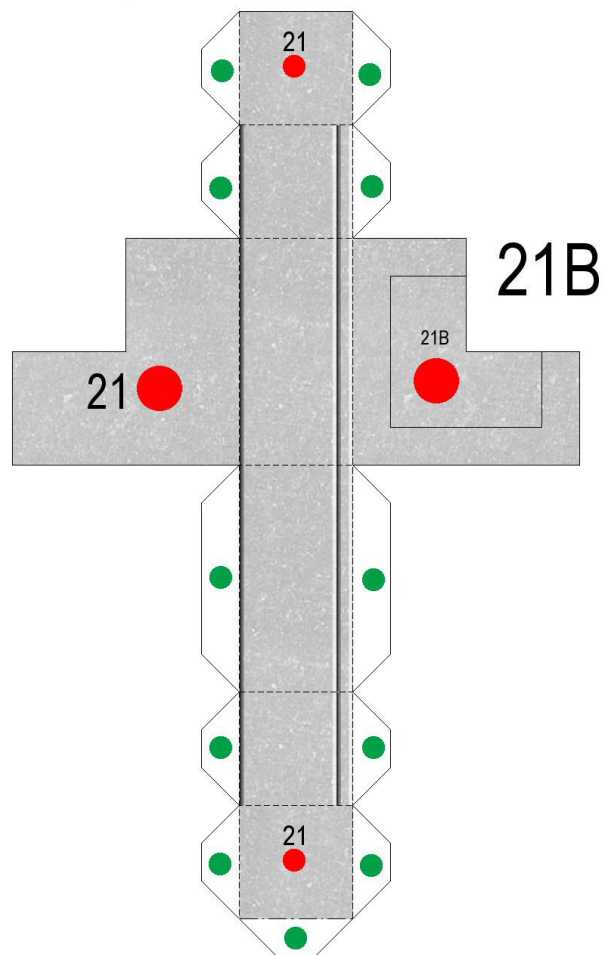
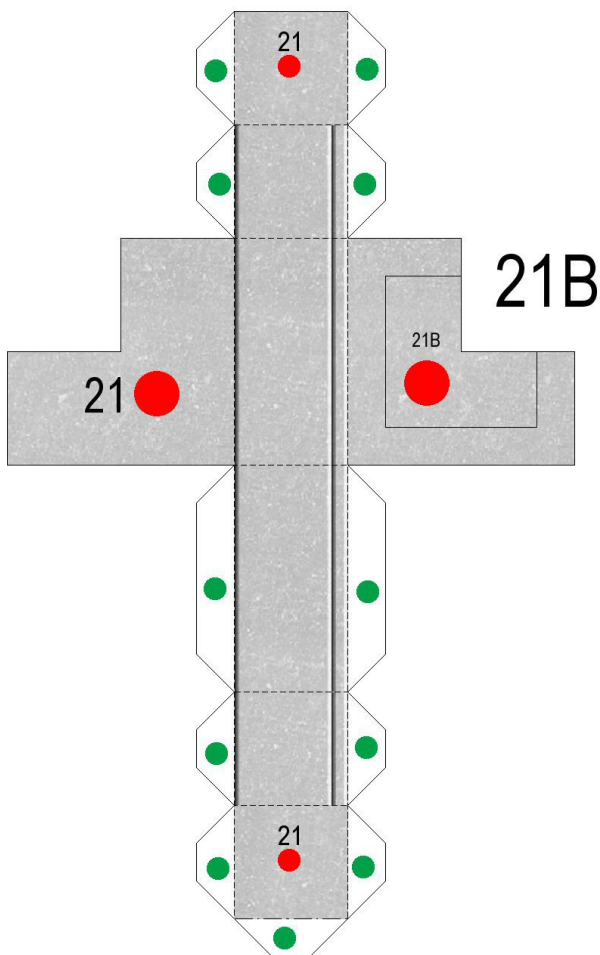
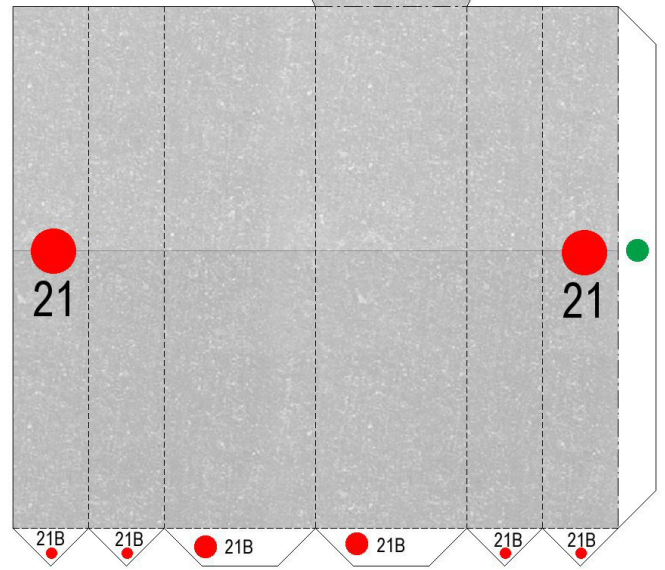
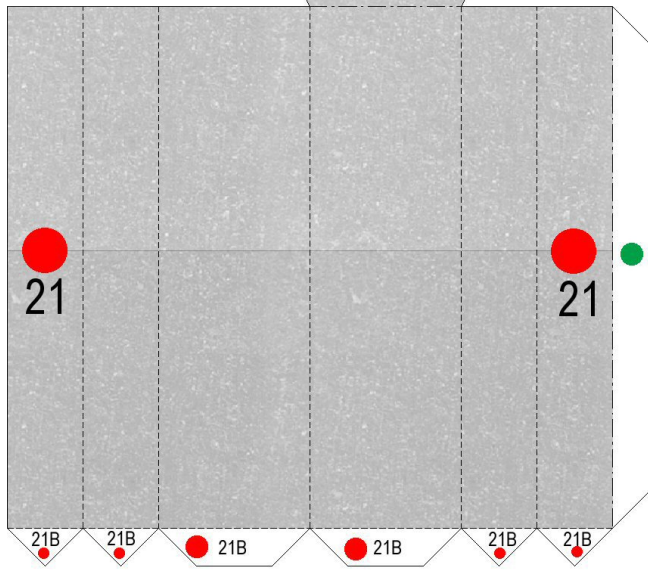
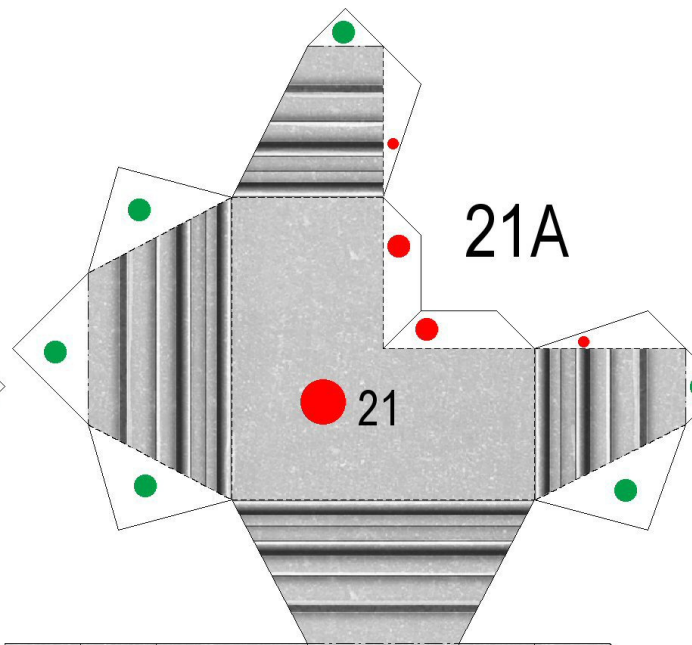
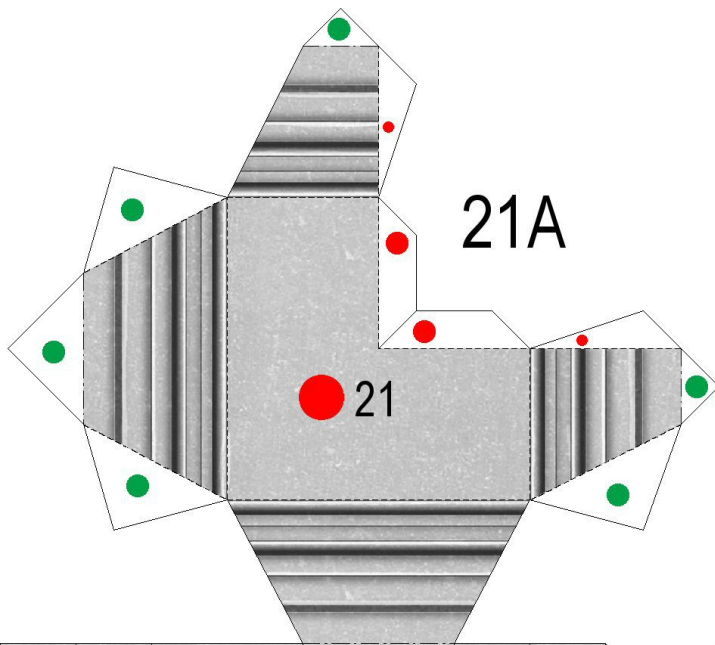

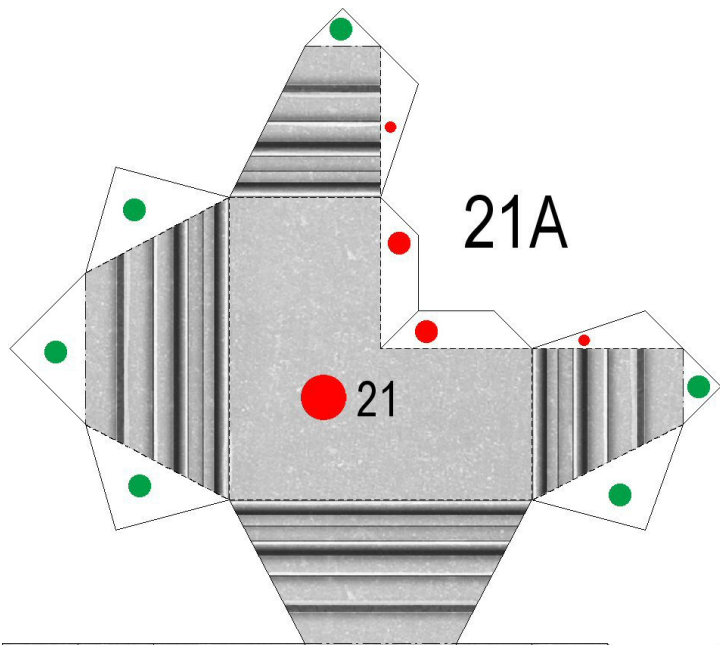

21A

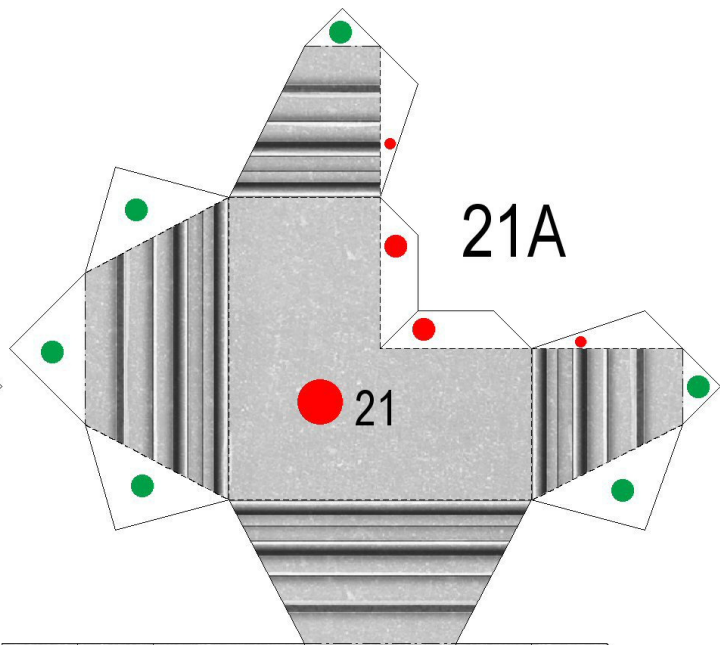

21A

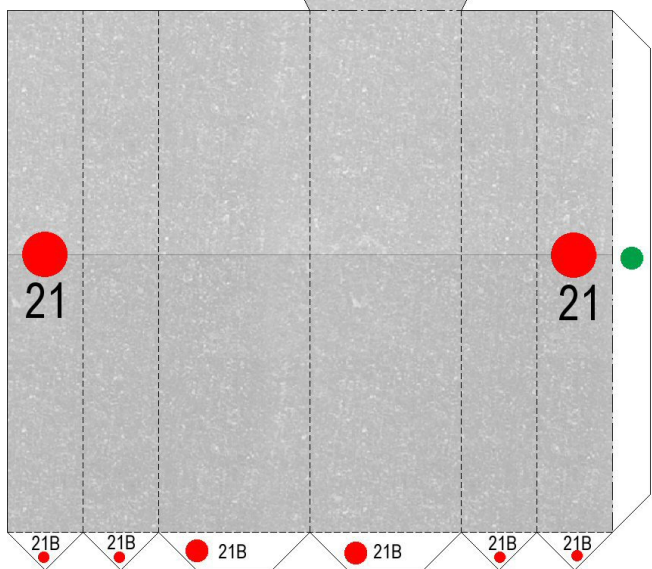

21

21

21B

21B

21B

21B

21B

21B

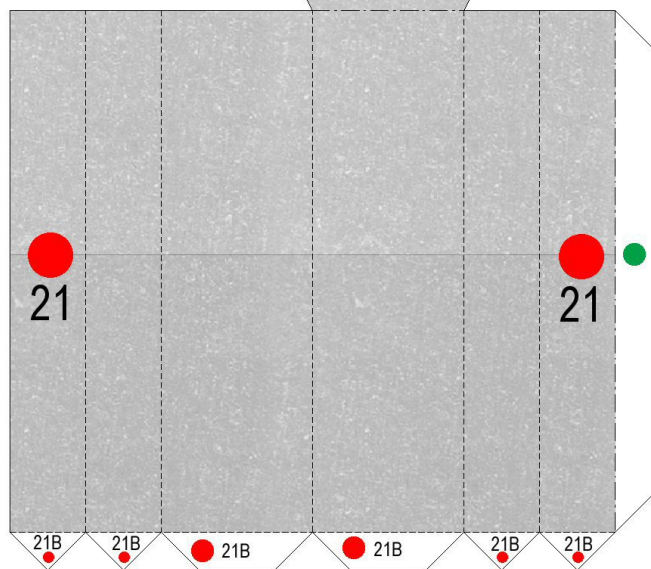

21

21

21B

21B

21B

21B

21B

21B

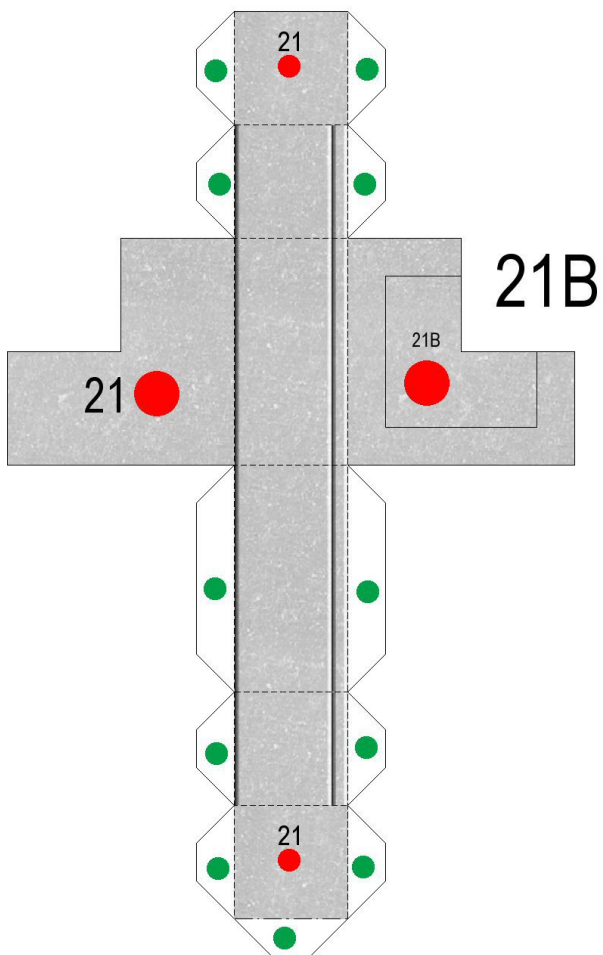

21B

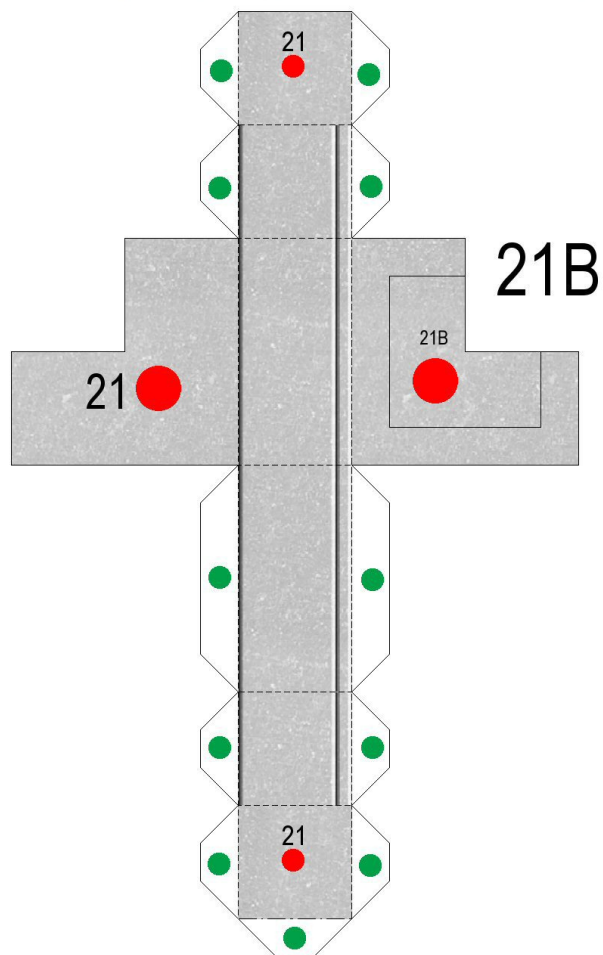

21B

22A

● 22B

● 23

● 22B

22B

● 22A

● 22A

22A ●

● 21

● 20

● 22

● 22

● 22

● 22

● 21

● 20

● 22A

22A ●

● 22A

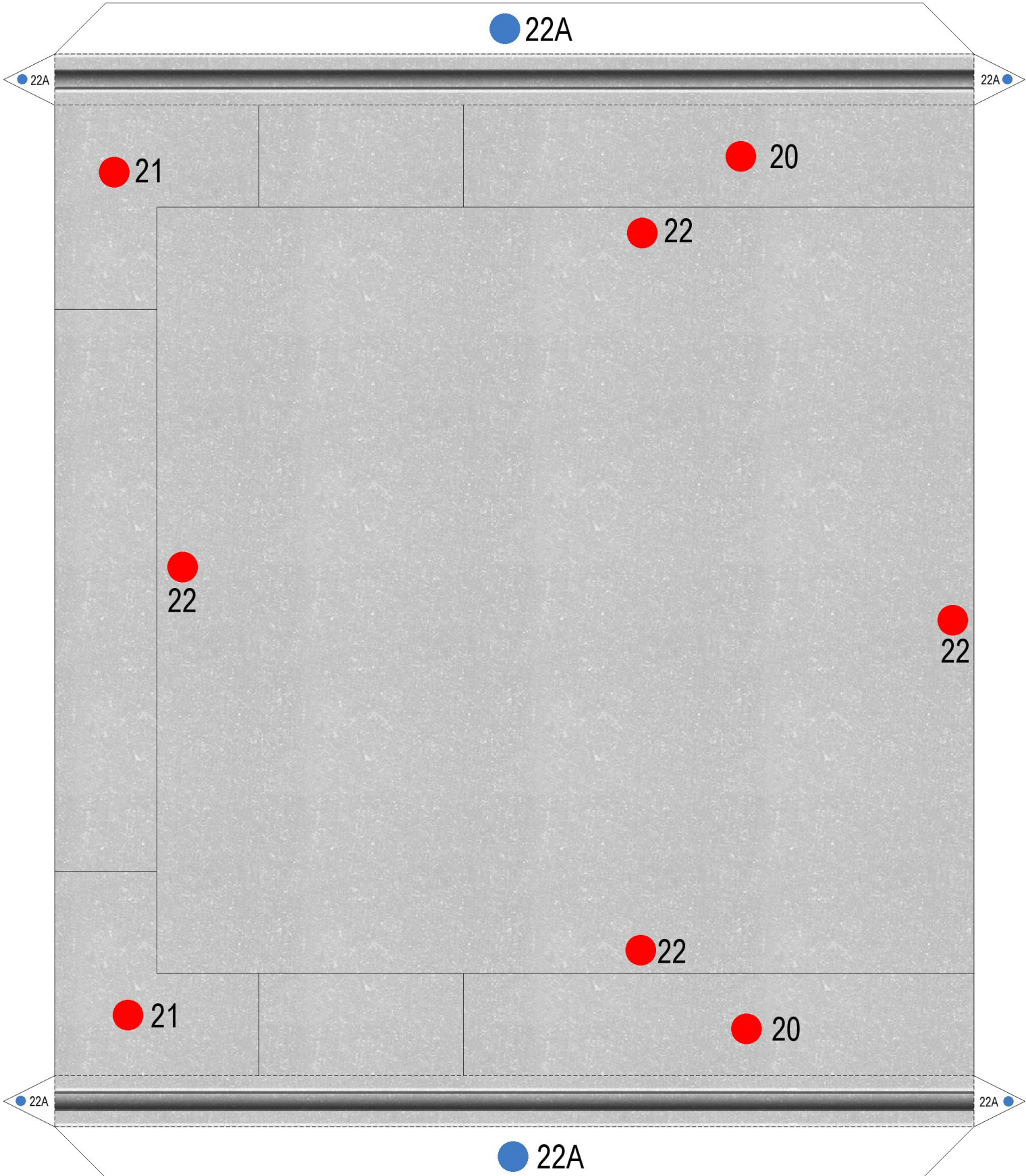

23A

● 23B

● 23

● 23B

23B

● 23A

● 23A

23A ●

● 21

● 20

● 23

● 23

● 23

● 23

● 21

● 20

● 23A

23A ●

● 23A

